

System 6
Dual Trigger Rotary Handpiece

REF 6205

stryker®

Instructions For Use

R_x ONLY

CE 0197

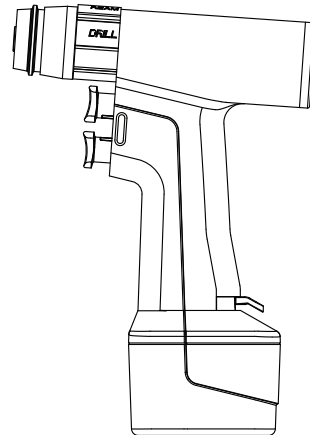

Important Information

The words WARNING, CAUTION and NOTE have special meaning and should be reviewed.

WARNING: Disregarding WARNING information may compromise the safety of the patient and/or health care staff and may result in injury.

CAUTION: Disregarding CAUTION information may compromise product reliability and may result in damage.

NOTE: NOTE information supplements and/or clarifies procedural information.



A triangle with an exclamation point alerts the health care professional to read and understand the accompanying instructions, especially the operating, maintenance, and safety information.

Intended Use

The Stryker System 6 Battery Powered Heavy Duty Dual Trigger Rotary Handpiece, when used with a variety of attachments, is intended for surgical procedures involving drilling, reaming, driving wire or pins, cutting bone and hard tissue.

Accessory Information*



WARNING: Use only Stryker-approved components and accessories, unless otherwise specified. Other accessories may result in increased electromagnetic emissions or decreased electromagnetic immunity of the system. DO NOT modify any component or accessory. Failure to comply may result in patient and/or health care staff injury.

DESCRIPTION	REF
Small Battery Pack.....	6212
Large Battery Pack	6215
Aseptic Battery Kit.....	6126
Small Aseptic Battery Kit	6127

*See the *System 6 Rotary Handpiece Attachments* booklet for a complete list of attachments. Contact your Stryker sales representative for a complete list of additional accessories.

User/Patient Safety*



WARNINGS:

- Only trained and experienced health care professionals should use this equipment. Before using any system component or any component compatible with this system, read and understand the instructions. Pay special attention to WARNING information. Become familiar with the system components prior to use. Failure to comply may result in patient and/or health care staff injury.
- Upon initial receipt and before each use, operate the equipment and inspect each component for damage. DO NOT use any component if damage is apparent. Failure to comply may result in patient and/or health care staff injury.
- Perform recommended periodic maintenance as indicated in the instructions for use. Only trained and experienced health care professionals should maintain this equipment.
- Clean and sterilize handpieces, attachments and batteries before first and every use.
- DO NOT use this equipment in the presence of a mixture consisting of flammable anesthetic and air or with oxygen or nitrous oxide.
- Take special precautions regarding electromagnetic compatibility (EMC) when using medical electrical equipment like the handpiece. Install and place the handpiece into service according to the EMC information in this manual. Portable and mobile RF communications equipment can affect the function of the handpiece.
- ALWAYS place the handpiece in the safe mode while the handpiece is idle, before installing or removing any accessory, or when passing the handpiece to another person. Failure to comply may result in patient and/or health care staff injury.
- A wobbling attachment may cause bone or tissue damage or inaccurate wiring or pin placement. If wobbling occurs, see *Troubleshooting Guide*. Failure to comply may result in patient injury.
- DO NOT apply excessive pressure, such as bending or prying, with a cutting accessory to prevent fracturing the accessory. Applying excessive pressure, especially during high operating speeds, may cause the cutting accessory to bend significantly and result in tissue damage, loss of tactile control and the ejection of cutting accessory pieces at a high velocity. Failure to comply may result in patient and/or health care staff injury.
- DO NOT reuse single use cutting accessories. Failure to comply may result in patient and/or health care staff injury.

*If you need more information, contact your Stryker sales representative or call Stryker customer service at 1-800-253-3210. Outside the US, contact your nearest Stryker subsidiary.

Features

- **Battery Latch** - To release the battery pack from the handpiece, depress the battery latch.
- **Battery Pack** - Rechargeable battery pack provides power to the handpiece.
- **Reverse Trigger** - To cause counterclockwise rotation and vary speed, press this pressure-sensitive trigger.
- **Forward Trigger** - To cause clockwise rotation and vary speed, press this pressure-sensitive trigger.
- **F/R/Safe Control** - Based on its position, allows the handpiece to operate in forward, reverse, or oscillate mode; safe mode prevents the operation of the handpiece.
- **Actuating Collar** - To release the attachment, slide the actuating collar.
- **Shifter Knob** - To select the handpiece mode of REAM [slow] or DRILL [fast], rotate the knob to the appropriate position, as required.
- **Accessory Interface** - Connector provides power and communication for future accessories.

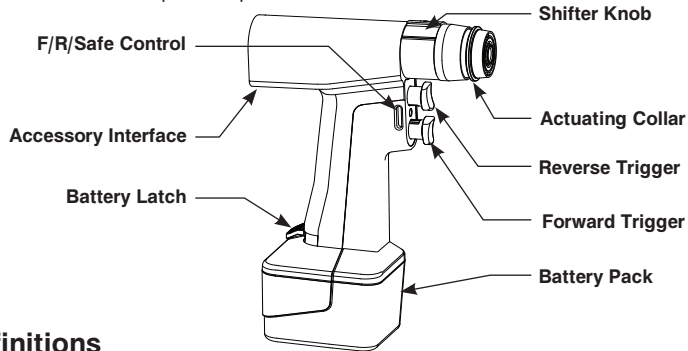

Symbol Definitions

<p>F FORWARD - Fully depress the F/R/Safe control to lock the reverse trigger. The forward trigger is functional.</p>	<p>R REVERSE - Press trigger to operate in the counterclockwise direction.</p>	<p>REAM REAM - For slow speed, rotate the shifter knob to REAM.</p>
<p>S SAFETY - Center the F/R/Safe control to lock both triggers.</p>	<p>OSCILLATE - Press both triggers to operate the handpiece in the oscillate mode.</p>	<p>DRILL DRILL - For fast speed, rotate the shifter knob to DRILL.</p>
<p>F/R FORWARD/REVERSE - Fully extend the F/R/Safe control to unlock both triggers. Both triggers are functional.</p>	<p>F FORWARD - Press trigger to operate in the clockwise direction.</p>	

Instructions

To Install Attachment



WARNING: To prevent inadvertent running of the handpiece, ALWAYS place the F/R/Safe control in the safe position before installing or removing any attachment.

NOTE: Several attachments are available and each has a specialized accessory retainer.

1. Slide the F/R/Safe control to the safe position.
2. To install an attachment, align the driveshaft of the attachment with the handpiece spindle. If the attachment has notches, also align the notches with the tabs in the sleeve of the handpiece (see figure 1).

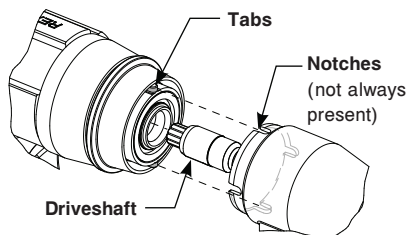

Figure 1 To Install Attachment

3. Once properly aligned, insert the attachment into the handpiece until the attachment “snaps” into place.
4. Tug the attachment to ensure it is secure.
5. Install the desired cutting accessory. See the *System 6 Rotary Handpiece Attachments* booklet.

To Install Battery Pack

NOTES:

- This handpiece is designed to accept a Stryker Large or Small Battery Pack only (REF 6215 or REF 6212). These battery packs can be charged in the Stryker System 6 Battery Charger REF 6110-120 configured with the appropriate battery charger modules.
 - See the instructions supplied with the battery charger and/or battery pack for charging details and specifications.
1. Slide a fully charged battery pack firmly into the handpiece until the battery latch snaps, indicating the battery pack is secure (see figure 2).

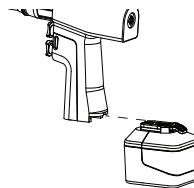

Figure 2 To Install Battery Pack

2. Test the operation of the handpiece by sliding the F/R/Safe control to FORWARD (F) or FORWARD/REVERSE (F/R) and squeezing the trigger.
3. Slide the F/R/Safe control to the safe position until you are ready to use the handpiece.

Instructions (cont'd)

To Operate Handpiece



WARNING: ALWAYS place the F/R/Safe control in the safe position while the handpiece is idle, before installing or removing an accessory, or when passing the handpiece to another person. Failure to comply may result in patient and/or health care staff injury.

CAUTIONS:

- DO NOT stall the handpiece. Failure to comply may damage the electric motor and/or battery pack. If the handpiece jams, release the trigger immediately. Remove any obstructions before continuing the procedure.
 - If any power loss is experienced while using a handpiece, ALWAYS replace the battery pack with a fully charged battery pack. Failure to comply may result in a drained or damaged battery pack with a shortened life.
1. Slide the F/R/Safe control to the appropriate position to allow the handpiece to operate in the forward, reverse or oscillate mode.
 2. Squeeze the appropriate pressure sensitive trigger for variable speed operation. For oscillation, squeeze both triggers simultaneously.
 3. Slide the F/R/Safe control to the safe position when you are finished operating the handpiece.

To Change Handpiece Speed



WARNINGS:

- DO NOT change the handpiece speed while operating the handpiece. Failure to comply may result in patient and/or health care staff injury.
- DO NOT use a reamer in the handpiece and operate the handpiece in the DRILL mode. Failure to comply may cause wobble and result in patient and/or health care staff injury.

1. Ensure the handpiece is not running.
2. Change the handpiece speed as follows:
 - For DRILL mode, rotate the shifter knob counter-clockwise until it clicks in place.
 - For REAM mode, rotate the shifter knob clockwise until it clicks in place.
3. Test the operation of the handpiece.
4. Slide the F/R/Safe control to the safe position until you are ready to use the handpiece.

To Remove Attachment

1. Slide the F/R/Safe control to the safe position.
2. Slide the actuating collar back to release the attachment.

To Remove Battery Pack

Depress the battery latch and pull the battery pack out of the handpiece.

Troubleshooting Guide*

<u>PROBLEM</u>	<u>CAUSE</u>	<u>ACTION</u>
Handpiece does not run or turns at a reduced speed.	Battery pack is discharged.	Recharge the battery pack in Stryker battery charger.
	Battery pack is expended.	Replace the battery pack.
	F/R/Safe control is in the safe position.	Slide F/R/Safe control to the forward or forward/reverse position.
	Drivetrain is malfunctioning.	Return the handpiece for repair.
Motor runs but cutting accessory does not move.	Drivetrain is malfunctioning.	Return the handpiece for repair.
	Attachment is not fully seated.	Remove and insert the attachment. Ensure the attachment is fully seated.
	Shifter knob is positioned between the DRILL and REAM selections.	Position shifter knob to either the DRILL or REAM position.
Battery pack becomes unusually hot during use.	Circuitry is malfunctioning.	Check the battery pack on the charger. Replace the battery pack if required. See the instructions supplied with the battery charger.
Attachment will not fit into the handpiece.	Debris is on the attachment or inside the front end of the handpiece.	Clean the attachment and/or handpiece with a small brush with stiff, non-metallic bristles.
	Attachment is damaged.	Return the attachment for repair.
	Handpiece is damaged.	Return the handpiece for repair.
Attachment and/or cutting accessory wobbles in handpiece.	Cutting accessory or wire/pin is bent, extends too far from the distal end of attachment, is the wrong size, or is not properly centered in the attachment.	Reinsert the cutting accessory, wire or pin. If wobble persists, return the handpiece and attachment for repair.
	A reamer is installed and the handpiece is in the DRILL mode.	ALWAYS operate reamers in the REAM mode.

*DO NOT service this equipment. If you require service, contact your Stryker sales representative or call Stryker customer service at 1-800-253-3210. Outside the US, contact your nearest Stryker subsidiary.

Troubleshooting Guide (cont'd)

PROBLEM	CAUSE	ACTION
Handpiece has become noisy and vibrates.	Drivetrain is malfunctioning.	Return the handpiece for repair.
Sporadic electrical interference is experienced.	Electrical noise is present.	<p>Turn off all electrical equipment not in use in the operating room.</p> <p>Relocate electrical equipment; increase spatial distance.</p> <p>Plug operating room equipment into different operating room outlets.</p>

Periodic Maintenance

INTERVAL	ACTIVITY
Prior to each use.	Inspect, operate and test the handpiece to ensure that it is working properly. Ensure that there are no loose or missing components. Check all moving parts for free movement. Be alert for unusual sounds or vibrations and note the operating speed.

Storage and Handling

To ensure the longevity, performance and safety of this equipment, use the original packaging materials when storing or transporting this equipment.

Cleaning Recommendations



WARNINGS:

- Clean and sterilize handpieces, attachments and batteries before first and every use.
- Prior to cleaning and sterilization, remove all attachments and accessories from the handpieces.
- DO NOT use solvents, lubricants, or other chemicals unless otherwise specified.

CAUTIONS:

- DO NOT immerse a handpiece, attachment or battery pack in liquid. Moisture may enter the equipment, cause corrosion, and damage the electrical and/or mechanical components.
- DO NOT allow liquid to run directly into any electrical connection. Moisture may cause corrosion to electrical and/or mechanical components.

To Clean Battery Packs and Accessories

See the care instructions supplied with the battery packs, battery pack modules and battery charger.

To Clean Handpiece and Attachments

1. Remove the battery pack and attachment from the handpiece.
2. Using a brush with stiff, non-metallic bristles and hospital enzymatic cleaner, scrub the debris from the handpiece and attachments. Pay special attention to crevices and other hard to reach areas such as seams, joints, and details around the retainer, trigger, and connector areas. Use a bottle brush to clean the cannula.
3. Rinse all external surfaces of the handpiece under tap water. Hold the handpiece upright to prevent water from running into the battery contact area. Flush the cannula with running water.
4. If water leaks into the handpiece, tip the handpiece back as shown below to allow drainage from a small opening in the battery pack contact area.

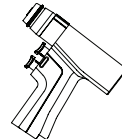

To Drain Water From Handpiece

5. Visually inspect the handpiece for any remaining debris; if any debris is present, repeat the cleaning and rinsing procedure using fresh hospital enzymatic cleaner.
6. Dry the handpiece and attachments with a lint-free towel.
7. After cleaning, sterilize as directed. See *Sterilization Recommendations*.

Sterilization Recommendations*



WARNINGS:

- Clean and sterilize handpieces, attachments and batteries before first and every use.
- Prior to cleaning and sterilization, remove attachments and all accessories from the handpieces.
- Orient the handpiece to allow steam to flow through the cannulated handpiece when using a gravity displacement sterilizer.

To Sterilize Battery Packs

See the care instructions supplied with the battery packs.

To Sterilize Handpieces and Attachments

To obtain optimal performance and prevent damage, perform one of the following sterilization procedures:

“Flash” Autoclave:

- Gravity displacement sterilizer
- 270-272 °F (132-134 °C)
- Unwrapped in an instrument tray in a vertical position so steam can flow through the cannula
- 10-minute minimum exposure time

Hi Vac:

- Pre-vacuumed sterilizer
- 270-272 °F (132-134 °C)
- Wrapped or unwrapped
- 4-minute minimum exposure time
- 8-minute minimum dry time

ETO:

- 100% ETO
- 120-135 °F (49-57 °C)
- Wrapped in an instrument tray or fully perforated sterilization box
- 2-hour 30-minute exposure time, 8-hour minimum aeration time

250 °F Gravity:

- Gravity displacement sterilizer
- 250-254 °F (121-123 °C)
- Wrapped in an instrument tray or fully perforated sterilization box
- 50-minute exposure time
- 8-minute minimum drying time







270 °F Gravity:

- Gravity displacement sterilizer
- 270-272 °F (132-134 °C)
- Wrapped in an instrument tray or fully perforated sterilization box
- 35-minute minimum exposure time
- 8-minute minimum dry time

*Validation is based on the Association for the Advancement of Medical Instrumentation (AAMI) protocol.

NOTE: After sterilization, allow the equipment to cool to room temperature to ensure a comfortable operating temperature.

Specifications*

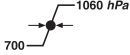
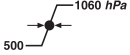
Model:	REF 6205 Dual Trigger Rotary Handpiece	
Size:	8.6 in. [219 mm] height (with large battery pack) 1.5 in. [38 mm] width 6.0 in. [153 mm] length	
Weight:	3.5 lbs. [1.6 kg] (with large battery pack)	
Speed:	1200 rpm (drill); 270 rpm (ream)	
Duty Cycle:		Intermittent Operation - 1 minute on/4 minutes off 3 times with 3 hour rest
Approval:		CSA International CAN/CSA-C22.2 No. 601.1-M90 UL 60601-1 IEC 60601-1
Equipment Type:		Type BF Applied Part
Power Supply:	Internally Powered 9.6 V ---	
Enclosure Protection:	IPX0 Ordinary Equipment	
Environmental Conditions:	Operation	Storage and Transportation
Temperature:		
Relative Humidity:		
Atmospheric Pressure:		

*Specifications are approximate and may vary from unit to unit or as a result of power supply fluctuations.

Specifications (cont'd)

Guidance and manufacturer's declaration - electromagnetic emissions		
The System 6 handpiece is intended for use in the electromagnetic environment specified below. The customer or the user of the System 6 handpiece should assure that it is used in such an environment.		
Emissions test	Compliance	Electromagnetic environment - guidance
RF emissions CISPR 11	Group 1	The System 6 handpiece uses RF energy only for its internal function. Therefore, its RF emissions are very low and are not likely to cause any interference in nearby electronic equipment. The System 6 handpiece is suitable for use in all establishments, including domestic establishments and those directly connected to the public low-voltage power supply network that supplies buildings used for domestic purposes.
RF emissions CISPR 11	Class B	
Harmonic emissions IEC 61000-3-2	n/a	
Voltage fluctuations/ flicker emissions IEC 61000-3-3	n/a	

Specifications (cont'd)

Guidance and manufacturer's declaration - electromagnetic immunity			
The System 6 handpiece is intended for use in the electromagnetic environment specified below. The customer or the user of the System 6 handpiece should assure that it is used in such an environment.			
Immunity test	IEC 60601 test level	Compliance level	Electromagnetic environment - guidance
Conducted RF IEC 61000-4-6 Radiated RF IEC 61000-4-3	3 Vrms 150 kHz to 80 MHz 3 V/m 80 MHz to 2.5 GHz	n/a n/a 3 V/m 80 MHz to 2.5 GHz	<p>Portable and mobile RF communications equipment should be used no closer to any part of the System 6 handpiece, including cables, than the recommended separation distance calculated from the equation applicable to the frequency of the transmitter.</p> <p>Recommended separation distance</p> $d=1.67\sqrt{P}$ $d=1.67\sqrt{P}$ 80 MHz to 800 MHz $d=2.33\sqrt{P}$ 800 MHz to 2.5 GHz Where P is the maximum output power rating of the transmitter in watts (W) according to the transmitter manufacturer and d is the recommended separation distance in meters (m) Interference may occur in the vicinity of equipment marked with the following symbol: <div style="text-align: center;">  </div>
NOTE 1: At 80 MHz and 800MHz the higher frequency range applies.			
NOTE 2: These guidelines may not apply in all situations. Electromagnetic propagation is affected by absorption and reflection from structures, objects and people.			

Specifications (cont'd)

Guidance and manufacturer's declaration - electromagnetic immunity			
The System 6 handpiece is intended for use in the electromagnetic environment specified below. The customer or the user of the System 6 handpiece should assure that it is used in such an environment.			
Immunity test	IEC 60601 test level	Compliance level	Electromagnetic environment - guidance
Electrostatic discharge (ESD) IEC 61000-4-2	±6 kV contact ±8 kV air	±2, 4, 6 kV contact ±2, 4, 8 kV air	Floors should be wood, concrete or ceramic tile. If floors are covered with synthetic material, the relative humidity should be at least 30%.
Electrical fast transient/burst IEC 61000-4-4	±2 kV for power supply lines ±1 kV for input/output lines	n/a n/a	
Surge IEC 61000-4-5	±1 kV differential mode ±2 kV common mode	n/a n/a	
Voltage dips, short interruptions and voltage variations on power supply input lines IEC 61000-4-11	<5% U_T (>95% dip in U_T) for 0,5 cycle 40% U_T (60% dip in U_T) for 5 cycles 70% U_T (30% dip in U_T) for 25 cycles <5% U_T (>95% dip in U_T) for 5 sec	n/a n/a n/a n/a	
Power frequency (50/60 Hz) magnetic field IEC 61000-4-8	3 A/m	3 A/m	Power frequency magnetic fields should be at levels characteristics of a typical location in a typical commercial or hospital environment.
NOTE: U_T is the alternating current mains voltage prior to application of the test level.			

Specifications (cont'd)

Recommended separation distances between portable and mobile RF communications equipment and the System 6 handpiece

The System 6 handpiece is intended for use in the electromagnetic environment in which radiated RF disturbances are controlled. The customer or the user of the System 6 handpiece can help prevent electromagnetic interference by maintaining a minimum distance between portable and mobile RF communications equipment (transmitters) and the System 6 handpiece as recommended below, according to the maximum output power of the communications equipment.

Rated maximum output power of transmitter W	Separation distance according to frequency of transmitter m		
	150 kHz to 80 MHz $d = \left[\frac{3,5}{V_1} \right] \sqrt{P}$	80 MHz to 800 MHz $d = \left[\frac{3,5}{E_1} \right] \sqrt{P}$	800 MHz to 2.5 GHz $d = \left[\frac{7}{E_1} \right] \sqrt{P}$
0.01	n/a	0.12	0.23
0.1	n/a	0.37	0.74
1	n/a	1.17	2.33
10	n/a	3.70	7.37
100	n/a	11.70	23.30

For transmitters rated at a maximum output power not listed above, the recommended separation distance d in meters (m) can be estimated using the equation applicable to the frequency of the transmitter, where P is the maximum output power rating of the transmitter in watts (W) according to the transmitter manufacturer.

NOTE 1: At 80 MHz and 800MHz, the separation distance for the higher frequency range applies.

NOTE 2: These guidelines may not apply in all situations. Electromagnetic propagation is affected by absorption and reflection from structures, objects and people.

6205-001-710
6205-001-720
6205-001-730
6205-001-750

ES/DE/FR/IT/NL
JA/ZH/KO
SV/DA/FI/PT/NO
PL/EL

Stryker Instruments

4100 E. Milham
Kalamazoo, Michigan
(USA) 49001
1-269-323-7700
1-800-253-3210



Stryker France
ZAC Satolas Green Pusignan
Av. de Satolas Green
69881 MEYZIEU Cedex
France

stryker[®]