

**System 6
Sagittal Saw**

REF 6208

stryker®

Instructions For Use

R_x ONLY

CE 0197

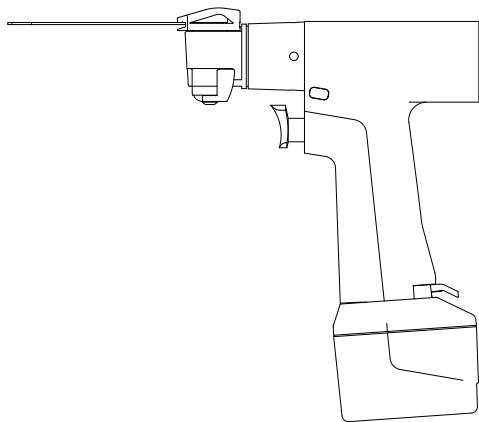

US Patents: 5,263,972; 5,747,953; 6,013,991

2007/09

6208-001-701 Rev-B

www.stryker.com

Important Information

The words WARNING, CAUTION and NOTE have special meaning and should be reviewed.

WARNING: Disregarding WARNING information may compromise the safety of the patient and/or health care staff and may result in injury.

CAUTION: Disregarding CAUTION information may compromise product reliability and may result in damage.

NOTE: NOTE information supplements and/or clarifies procedural information.



A triangle with an exclamation point alerts the health care professional to read and understand the accompanying instructions, especially the operating, maintenance, and safety information.

Intended Use

The Stryker System 6 Battery Powered Heavy Duty Sagittal Saw is an oscillating cutting device used for cutting bone and bone related tissue.

Accessory Information*



WARNINGS:

- Use only Stryker-approved components and accessories, unless otherwise specified. Other accessories may result in increased electromagnetic emissions or decreased electromagnetic immunity of the system. DO NOT modify any component or accessory. Failure to comply may result in patient and/or health care staff injury.
- ALWAYS use Stryker sagittal saw blades with this handpiece. Failure to comply may result in patient and/or health care staff injury.

DESCRIPTION

REF

Large Battery Pack 6215

*Contact your Stryker sales representative for a complete list of additional accessories.

User/Patient Safety*



WARNINGS:

- Only trained and experienced health care professionals should use this equipment. Before using any system component or any component compatible with this system, read and understand the instructions. Pay special attention to WARNING information. Become familiar with the system components prior to use. Failure to comply may result in patient and/or health care staff injury.
- Upon initial receipt and before each use, operate the equipment and inspect each component for damage. DO NOT use any component if damage is apparent. Failure to comply may result in patient and/or health care staff injury.
- Perform recommended periodic maintenance as indicated in the instructions for use. Only trained and experienced health care professionals should maintain this equipment.
- Clean and sterilize handpieces and batteries before first and every use.
- DO NOT use this equipment in the presence of a mixture consisting of flammable anesthetic and air or with oxygen or nitrous oxide.
- Take special precautions regarding electromagnetic compatibility (EMC) when using medical electrical equipment like the handpiece. Install and place the handpiece into service according to the EMC information in this manual. Portable and mobile RF communications equipment can affect the function of the handpiece.
- ALWAYS place the handpiece in the safe mode while the handpiece is idle, before installing or removing any accessory, or when passing the handpiece to another person. Failure to comply may result in patient and/or health care staff injury.
- DO NOT apply excessive pressure, such as bending or prying, with a cutting accessory to prevent fracturing the accessory. Failure to comply may result in patient and/or health care staff injury.
- DO NOT reuse single use cutting accessories. Failure to comply may result in patient and/or health care staff injury.

*If you need more information, contact your Stryker sales representative or call Stryker customer service at 1-800-253-3210. Outside the US, contact your nearest Stryker subsidiary.

Features

- **Battery Latch** - To release the battery pack from the handpiece, depress the battery latch.
- **Battery Pack** - Rechargeable battery pack that provides power to the handpiece.
- **Index Button** - To allow the indexing of the sagittal head, push the index button.
- **Blade Mount Lever** - Rotate the lever to the LOAD or RUN position to install or lock the blade into place.
- **Blade Retainer** - The retainer holds the blade.
- **Sagittal Head** - The sagittal head may be indexed in 45° increments and can turn in a complete 360° rotation to achieve the desired cutting angle.
- **Trigger Switch** - The trigger is pressure sensitive for variable speed operation.
- **FAST/STD/Safe Control** - Based on its position, allows the handpiece to operate in the FAST or STD mode; the safe mode prevents operation of the handpiece.
- **Accessory Interface** - Connector provides power and communication for future accessories.

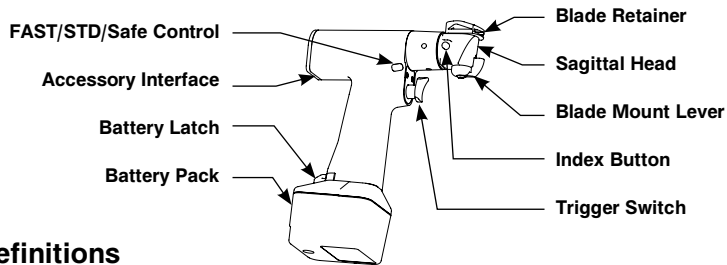

Symbol Definitions

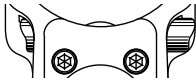

Fast ►►

Slide the FAST/STD/Safe control to the FAST position to allow the handpiece to operate at high torque and high speed when the trigger is depressed.

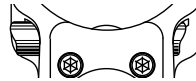

◄◄ **Std**

Slide the FAST/STD/Safe control to the STD (standard) position to allow the handpiece to operate at high torque and standard speed when the trigger switch is depressed.



Slide the FAST/STD/Safe control to the safe position to lock the trigger and prevent inadvertent operation of the handpiece; the handpiece cannot be operated.

The LOAD position allows the insertion of the blade into the handpiece.

LOAD



RUN

The RUN position locks the blade in the handpiece.

Instructions

To Install Cutting Accessory



WARNING: To prevent the inadvertent running of the handpiece, ALWAYS place the FAST/STD/safe control in the safe position before installing or removing any accessory.

1. Slide the FAST/STD/Safe control to the safe position.
2. Rotate the blade mount lever to the LOAD position.
3. Hold the handpiece in a vertical orientation with the sagittal head and blade entry slot facing up. (see figure 1).
4. Insert the blade into the slot. Ensure the full insert line of the blade disappears in the blade retainer indicating the blade is positioned properly.

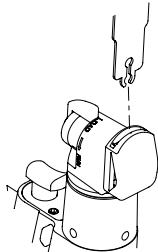

Figure 1 To Install Blade Rotate the Lever

5. Rotate the blade mount lever to the RUN position while maintaining the vertical orientation of the handpiece to lock the blade.
6. Gently tug the blade to ensure it is secure.

To Index Sagittal Head

CAUTION: Before operating the handpiece, ensure the sagittal head is locked into position. Failure to comply may result in product damage.

NOTE: The sagittal head has eight possible cutting angle positions (45° increments).

1. Push and hold the index button; rotate the sagittal head to the desired cutting angle (see figure 2).

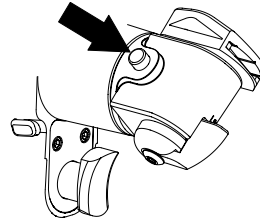

Figure 2 To Index Head Push the Button

2. Once the sagittal head is positioned, release the index button, and gently turn the sagittal head to ensure it is locked into position.

Instructions (cont'd)

To Install Battery Pack

NOTES:

- This handpiece is designed to accept the Stryker Large Battery Pack REF 6215 only. This battery pack can be charged in the Stryker System 6 Battery Charger REF 6110-120 configured with the appropriate battery charger module.
 - See the instructions supplied with the battery charger and/or battery pack for charging details and specifications.
1. Slide a fully charged battery pack firmly into the handpiece until the battery latch snaps, indicating the battery pack is secure (see figure 3).

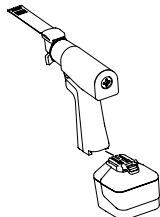

Figure 3 Install Battery Pack

2. Test the operation of the handpiece by sliding the FAST/STD/Safe control to the FAST or STD positions and squeezing the trigger.
3. Slide FAST/STD/Safe control to the safe position until you are ready to use the handpiece.

To Operate Handpiece



WARNING: ALWAYS place the FAST/STD/Safe control in the safe position while the handpiece is idle, before installing or removing an accessory, or when passing the handpiece to another person. Failure to comply may result in patient and/or health care staff injury.

CAUTIONS:

- When operating the handpiece, let the blade do the cutting. Applying too much pressure will bend the blade and reduce the cutting quality.
 - DO NOT stall the handpiece. Failure to comply may damage the electric motor and/or battery pack. If the handpiece jams, release the trigger immediately. Remove any obstructions before continuing the procedure.
 - If any power loss is experienced while using a handpiece, ALWAYS replace the battery pack with a fully charged battery pack. Failure to comply may result in a drained or damaged battery pack with a shortened life.
1. Slide the FAST/STD/Safe control to the FAST or STD position to allow the handpiece to operate.
 2. Squeeze the pressure sensitive trigger for variable speed operation.
 3. Slide the FAST/STD/Safe control to the safe position when you are finished operating the handpiece.

To Remove Battery Pack

Depress the battery latch and pull the battery pack out.

To Remove Cutting Accessory

Rotate the blade mount lever to the LOAD position and remove the blade.

Periodic Maintenance

INTERVAL	ACTIVITY
Prior to each use.	Inspect, operate and test the hand-piece to ensure that it is working properly. Ensure that there are no loose or missing components. Check all moving parts for free movement. Be alert for unusual sounds or vibrations and note the operating speed.

Storage and Handling

To ensure the longevity, performance and safety of this equipment, use the original packaging materials when storing or transporting this equipment.

Troubleshooting Guide*

PROBLEM	CAUSE	ACTION
Handpiece does not run or oscillates at a reduced speed making cutting difficult.	Battery pack is discharged.	Recharge the battery pack in Stryker charger.
	FAST/STD/Safe control is in STD position.	Set the FAST/STD/Safe control to the FAST position.
	Battery pack is expended.	Replace the battery pack.
	FAST/STD/Safe control is in the safe position.	Set the FAST/STD/Safe control to the FAST or STD position.
Motor runs but blade does not move.	Drivetrain is malfunctioning.	Return the handpiece for repair.
	Drivetrain is malfunctioning.	Return the handpiece for repair.
Battery pack becomes unusually hot during use.	Circuitry is malfunctioning.	Check the battery pack on the charger. Replace the battery pack if required. See the instructions supplied with the battery charger.
Blade will not fit into the blade retainer or cannot be secured.	Debris is inside the end of the blade retainer.	Clean the handpiece with a small brush.
	Blade is not a Stryker product.	Use a Stryker blade.
	Blade retainer is damaged.	Return the handpiece for repair.
Handpiece has become noisy and vibrates.	Blade is not a Stryker product.	Use a Stryker blade.
	Drivetrain is malfunctioning.	Return the handpiece for repair.
Sporadic electrical interference is experienced.	Electrical noise is present.	Turn off all electrical equipment not in use in the operating room.
		Relocate electrical equipment; increase spatial distance.
		Plug operating room equipment into different operating room outlets.

*DO NOT service this equipment. If you require service, contact your Stryker sales representative or call Stryker customer service at 1-800-253-3210. Outside the US, contact your nearest Stryker subsidiary.

Cleaning Recommendations



WARNINGS:

- Clean and sterilize handpieces, and batteries before first and every use.
- Prior to cleaning and sterilization, remove all accessories from the handpieces.
- DO NOT use solvents, lubricants, or other chemicals unless otherwise specified.

CAUTIONS:

- DO NOT immerse a handpiece or battery pack in liquid. Moisture may enter the equipment, cause corrosion, and damage the electrical and/or mechanical components.
- DO NOT allow liquid to run directly into any electrical connection. Moisture may cause corrosion to electrical and/or mechanical components.

To Clean Battery Packs and Accessories

See the care instructions supplied with the battery packs, battery pack modules and battery charger.

To Clean Handpiece

1. Remove the battery pack and cutting accessory from the handpiece.
2. Using a brush with stiff, non-metallic bristles and hospital enzymatic cleaner, scrub the debris from the handpiece. Pay special attention to crevices and hard to reach areas such as seams, joints, and details around the blade retainer, trigger, and connector areas.
3. Rinse all external surfaces of the handpiece under running water. Hold the handpiece upright to prevent water from running into the battery contact area.
4. If water leaks into the handpiece, tip the handpiece back as shown to allow drainage from a small opening in the battery contact area.

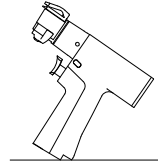

To Drain Water From Handpiece

5. Visually inspect the handpiece for any remaining debris; if any debris is present, repeat the cleaning and rinsing procedure using fresh hospital enzymatic cleaner.
6. Dry the handpiece with a lint-free towel.
7. After cleaning, sterilize as directed. See *Sterilization Recommendations*.

Sterilization Recommendations*



WARNINGS:

- Clean and sterilize handpieces and batteries before first and every use.
- Prior to cleaning and sterilization, remove all accessories from the handpieces.

To Sterilize Battery Packs

See the care instructions supplied with the battery packs.

To Sterilize Handpieces

To obtain optimal performance and prevent damage, perform one of the following sterilization procedures:

“Flash” Autoclave:

- Gravity displacement sterilizer
- 270-272 °F (132-134 °C)
- Unwrapped in an instrument tray
- 10-minute minimum exposure time

Hi Vac:

- Pre-vacuumed sterilizer
- 270-272 °F (132-134 °C)
- Wrapped or unwrapped
- 4-minute minimum exposure time
- 8-minute minimum dry time

ETO:

- 100% ETO
- 120-135 °F (49-57 °C)
- Wrapped in an instrument tray or fully perforated sterilization box
- 2-hour 30-minute exposure time, 8-hour minimum aeration time

250 °F Gravity:

- Gravity displacement sterilizer
- 250-254 °F (121-123 °C)
- Wrapped in an instrument tray or fully perforated sterilization box
- 50-minute exposure time
- 8-minute minimum drying time







270 °F Gravity:

- Gravity displacement sterilizer
- 270-272 °F (132-134 °C)
- Wrapped in an instrument tray or fully perforated sterilization box
- 35-minute minimum exposure time
- 8-minute minimum dry time

*Validation is based on the Association for the Advancement of Medical Instrumentation (AAMI) protocol.

NOTE: After sterilization, allow the equipment to cool to room temperature to ensure a comfortable operating temperature.

Specifications*

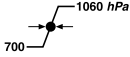
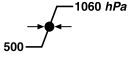
Model:	REF 6208 Sagittal Saw	
Size:	8.5 in. [216 mm] height (with large battery pack) 1.5 in. [38 mm] width 6.4 in. [163 mm] length	
Weight:	3.5 lbs. [1.58 kg] (with large battery pack)	
Speed:	12,000 CPM (FAST mode); 10,000 CPM (STD mode)	
Excursion:	5° arc	
Duty Cycle:		Intermittent Operation - 1 minute on / 4 minutes off 5 times with a 3 hour rest
Approval:		CSA International CAN/CSA-C22.2 No. 601.1-M90 UL 60601-1 IEC 60601-1
Equipment Type:		Type BF Applied Part
Power Supply:	Internally Powered 9.6 V ---	
Enclosure Protection:	IPX0 Ordinary Equipment	
Environmental Conditions:	Operation	Storage and Transportation
Temperature:		
Relative Humidity:		
Atmospheric Pressure:		

*Specifications are approximate and may vary from unit to unit or as a result of power supply fluctuations.

Specifications (cont'd)

Guidance and manufacturer's declaration - electromagnetic emissions		
The System 6 handpiece is intended for use in the electromagnetic environment specified below. The customer or the user of the System 6 handpiece should assure that it is used in such an environment.		
Emissions test	Compliance	Electromagnetic environment - guidance
RF emissions CISPR 11	Group 1	The System 6 handpiece uses RF energy only for its internal function. Therefore, its RF emissions are very low and are not likely to cause any interference in nearby electronic equipment. The System 6 handpiece is suitable for use in all establishments, including domestic establishments and those directly connected to the public low-voltage power supply network that supplies buildings used for domestic purposes.
RF emissions CISPR 11	Class B	
Harmonic emissions IEC 61000-3-2	n/a	
Voltage fluctuations/ flicker emissions IEC 61000-3-3	n/a	

Specifications (cont'd)

Guidance and manufacturer's declaration - electromagnetic immunity			
The System 6 handpiece is intended for use in the electromagnetic environment specified below. The customer or the user of the System 6 handpiece should assure that it is used in such an environment.			
Immunity test	IEC 60601 test level	Compliance level	Electromagnetic environment - guidance
Conducted RF IEC 61000-4-6 Radiated RF IEC 61000-4-3	3 Vrms 150 kHz to 80 MHz 3 V/m 80 MHz to 2.5 GHz	n/a n/a 3 V/m 80 MHz to 2.5 GHz	<p>Portable and mobile RF communications equipment should be used no closer to any part of the System 6 handpiece, including cables, than the recommended separation distance calculated from the equation applicable to the frequency of the transmitter.</p> <p>Recommended separation distance</p> $d=1.67\sqrt{P}$ $d=1.67\sqrt{P}$ $d=2.33\sqrt{P}$ <p>80 MHz to 800 MHz 800 MHz to 2.5 GHz</p> <p>Where P is the maximum output power rating of the transmitter in watts (W) according to the transmitter manufacturer and d is the recommended separation distance in meters (m)</p> <p>Interference may occur in the vicinity of equipment marked with the following symbol:</p> 
NOTE 1: At 80 MHz and 800MHz the higher frequency range applies.			
NOTE 2: These guidelines may not apply in all situations. Electromagnetic propagation is affected by absorption and reflection from structures, objects and people.			

Specifications (cont'd)

Guidance and manufacturer's declaration - electromagnetic immunity			
The System 6 handpiece is intended for use in the electromagnetic environment specified below. The customer or the user of the System 6 handpiece should assure that it is used in such an environment.			
Immunity test	IEC 60601 test level	Compliance level	Electromagnetic environment - guidance
Electrostatic discharge (ESD) IEC 61000-4-2	±6 kV contact ±8 kV air	±2, 4, 6 kV contact ±2, 4, 8 kV air	Floors should be wood, concrete or ceramic tile. If floors are covered with synthetic material, the relative humidity should be at least 30%.
Electrical fast transient/burst IEC 61000-4-4	±2 kV for power supply lines ±1 kV for input/output lines	n/a n/a	
Surge IEC 61000-4-5	±1 kV differential mode ±2 kV common mode	n/a n/a	
Voltage dips, short interruptions and voltage variations on power supply input lines IEC 61000-4-11	<5% U_T (>95% dip in U_T) for 0,5 cycle	n/a	
	40% U_T (60% dip in U_T) for 5 cycles	n/a	
	70% U_T (30% dip in U_T) for 25 cycles	n/a	
	<5% U_T (>95% dip in U_T) for 5 sec	n/a	
Power frequency (50/60 Hz) magnetic field IEC 61000-4-8	3 A/m	3 A/m	Power frequency magnetic fields should be at levels characteristics of a typical location in a typical commercial or hospital environment.
NOTE: U_T is the alternating current mains voltage prior to application of the test level.			

Specifications (cont'd)

Recommended separation distances between portable and mobile RF communications equipment and the System 6 handpiece

The System 6 handpiece is intended for use in the electromagnetic environment in which radiated RF disturbances are controlled.

The customer or the user of the System 6 handpiece can help prevent electromagnetic interference by maintaining a minimum distance between portable and mobile RF communications equipment (transmitters) and the System 6 handpiece as recommended below, according to the maximum output power of the communications equipment.

Rated maximum output power of transmitter W	Separation distance according to frequency of transmitter m		
	150 kHz to 80 MHz $d = \left[\frac{3,5}{V_1} \right] \sqrt{P}$	80 MHz to 800 MHz $d = \left[\frac{3,5}{E_1} \right] \sqrt{P}$	800 MHz to 2.5 GHz $d = \left[\frac{7}{E_1} \right] \sqrt{P}$
0.01	n/a	0.12	0.23
0.1	n/a	0.37	0.74
1	n/a	1.17	2.33
10	n/a	3.70	7.37
100	n/a	11.70	23.30

For transmitters rated at a maximum output power not listed above, the recommended separation distance d in meters (m) can be estimated using the equation applicable to the frequency of the transmitter, where P is the maximum output power rating of the transmitter in watts (W) according to the transmitter manufacturer.

NOTE 1: At 80 MHz and 800MHz, the separation distance for the higher frequency range applies.

NOTE 2: These guidelines may not apply in all situations. Electromagnetic propagation is affected by absorption and reflection from structures, objects and people.

ES/DE/FR/IT/NL 6208-001-711
JA/ZH/KO 6208-001-721
SV/DA/FI/PT/NO 6208-001-731
EL/JPL 6208-001-751

Stryker Instruments

4100 E. Milham
Kalamazoo, Michigan
(USA) 49001
1-269-323-7700
1-800-253-3210

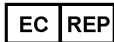

Stryker France
ZAC Satolas Green Pusignan
Av. de Satolas Green
69881 MEYZIEU Cedex
France

stryker[®]