

Babytherm® 8000 OC

Resuscitation/Open Care Unit

Instructions for Use



Contents

	Page		Page
For Your Safety and that of Your Patients	3	Oxygen Therapy	32
Intended Use	4	Safety precautions.....	32
Preparing the Warming Bed	5	Administering oxygen with the hood	33
Adjusting the height	5	Bronchial Aspiration	33
Storing	5	Babylog 2000	33
Fitting bronchial aspirator.....	6	Phototherapy	34
Preparing the Stand	7	X-Raying	34
Shelf.....	7	Care	35
Compact rail.....	7	Stripping down.....	35
Swivel table.....	8	Cleaning, disinfecting and sterilizing	35
Preparing accessories for oxygen therapy.....	8	Before the next use.....	35
Observe stability.....	9	Maintenance Intervals	36
Preparing the Cot	10	Disposal of NiCd batteries.....	36
Fitting the panels	10	Fault, Cause, Remedy	37
Fitting the holder for breathing tubes	11	What is what	39
Mattress	11	Technical Data	43
Fitting the cover	11	Design and Description	46
Tilting the resting surface	12	Order List	48
Preparing the unit for in-hospital transport.....	12	Index	50
Checking operational readiness	13		
Patient Care	14		
Safety precautions.....	14		
Heat Therapy	14		
Safety precautions.....	14		
Mattress Heating	15		
Safety precautions.....	15		
Checking operational readiness.....	15		
Operation.....	17		
Alarms.....	19		
Shut-down.....	19		
Radiant Heater.....	20		
Safety precautions.....	20		
Checking operational readiness.....	21		
Setting heat output manually.....	22		
Using skin temperature control.....	23		
Using timer.....	27		
Positioning halogen lamp.....	28		
Shut-down.....	28		
Notes on Settings of the Mattress and Radiant Heater Heating Systems	29		

For Your Safety and that of Your Patients

Strictly follow the Instructions for Use

Any use of the apparatus requires full understanding and strict observation of these instructions. The apparatus is only to be used for purposes specified here.

Maintenance

The apparatus must be inspected* and serviced* yearly by trained service personnel (and a record kept).

Repair* and general overhaul of the apparatus may only be carried out by trained service personnel.

We recommend that a service contract be obtained with DrägerService and that all repairs also be carried out by them. Only authentic Dräger spare parts may be used for maintenance*.

Observe chapter "Maintenance Intervals".

Not for use in areas of explosion hazard

This apparatus is neither approved nor certified for use in areas where combustible or explosive gas mixtures are likely to occur.

Liability for proper function or damage

The liability for the proper function of the apparatus is irrevocably transferred to the owner or operator to the extent that the apparatus is serviced or repaired by personnel not employed or authorized by DrägerService or if the apparatus is used in a manner not conforming to its intended use.

Dräger cannot be held responsible for damage caused by non-compliance with the recommendations given above. The warranty and liability provisions of the terms of sale and delivery of Dräger are likewise not modified by the recommendations given above.

Dräger Medizintechnik GmbH

*

Definitions:

Inspection	= examination of actual condition
Service	= measures to maintain specified condition
Repair	= measures to restore specified condition
Maintenance	= inspection, service, repair

Intended Use

Babytherm 8000 OC is an open care unit for warming premature babies, neonates and infants with a body weight of up to 5 kg.

The unit may be used in operating theatres, neonatal wards, children's wards and paediatric intensive care units.

The unit may be operated by clinical staff or by nursing staff under the supervision of a doctor.

Babytherm 8000 OC provides warmth by a radiant heater and, optionally, by a heated gel mattress.

Therapy and nursing uses:

- resuscitation station
- nursing station for normal and intensive care
- warming-up and compensation for heat loss
- thermal stabilising with mattress heating
- gentle heat therapy with a combination of radiant heater and mattress heating
- cooling patients with high temperatures (temperature of mattress below body temperature)
- resting surface adjustable for head-up or head-low position
- weaning of infants from an incubator
- oxygen and aerosol therapy with appropriate accessories
- timer for APGAR test

Babytherm 8000 OC heating features

- Radiant heater operating with set heat output: radiant heater output controlled in manual operating mode and therapy at raised heat output monitored.
- Radiant heater operating with skin temperature control: skin temperature is controlled and monitored.
- Optional heated mattress, independent of radiant heater: the temperature of the heating plate is controlled and monitored so that a pre-selected temperature is set for the contact surface between infant and mattress.

Skin temperature control must not be used on children who are in shock or have high temperatures.

Mobile radiotelephones must not be used within 10 metres of the equipment!

Mobile radiotelephones may cause malfunctions in electromedical equipment.

Options:

- mattress heating
- height adjustment
- swivel unit or two swivel units for Babytherm with height adjustment
- inner panels

The accessories included in the Order List can be used with the standard version. Not yet CE marked.

Optional therapy accessories:

- bronchial aspirator
- O₂ flowmeter
- O₂ distributor
- O₂ distributor with cylinder connection
- O₂ Oxydig monitor
- O₂ hood
- infusion bottle holder
- phototherapy unit

Preparing

Preparing the warming bed

Adjusting the height

The height adjustment is optional.

Before operation, always check:

- Connect the power supply.
 - 1 Press the right pedal briefly to raise the resting surface.
 - 2 Press the left pedal briefly to lower the resting surface.
-
- Adjust to comfortable working height.
 - Do not place objects in lifting area.

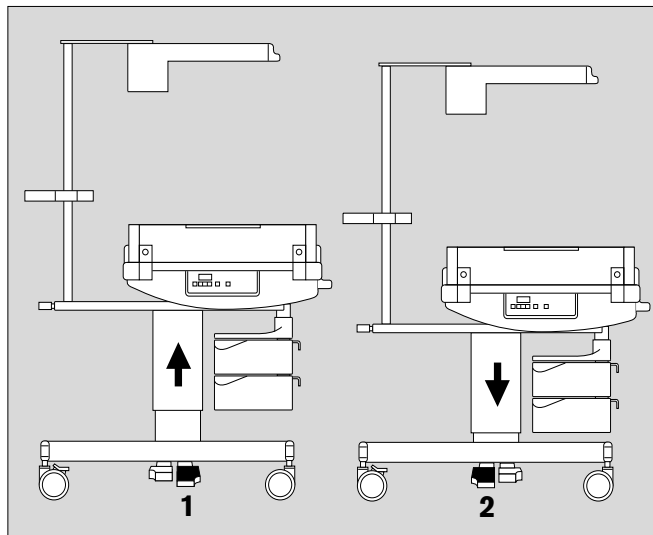

Storing

Unit with height adjustment:

- swivel unit with 2 compartments and 1 table surface, optional.

Unit without height adjustment:

- 2 open compartments in the column,
- 1 swivel unit with 2 compartments and 1 table surface, optional.

Fitting bronchial aspirator

- Prepare the aspirator in accordance with the relevant Instructions for Use and check.

Positioning ejector on compact rail

- Attach the compact rail to stand as required, see page 7.

1 Clamp the ejector to the compact rail.

- Attach the holder using the mounting pin:

Device with height adjustment

2 screw the holder to the column but keep the bottle holder clear of the swivelling area of the swivel unit.

Device with fixed column

- screw the holder to the left side of the column.

3 Attach the bottle holder to the mounting pin.

4 Connect the secretion jar to the ejector using the hose.

- Attach the hose holder to the compact rail.

5 Attach the aspiration hose and clip into the hose holder.

- Screw on the connecting hose and insert the probe into the terminal unit of the medical gas pipeline system (in parking position).

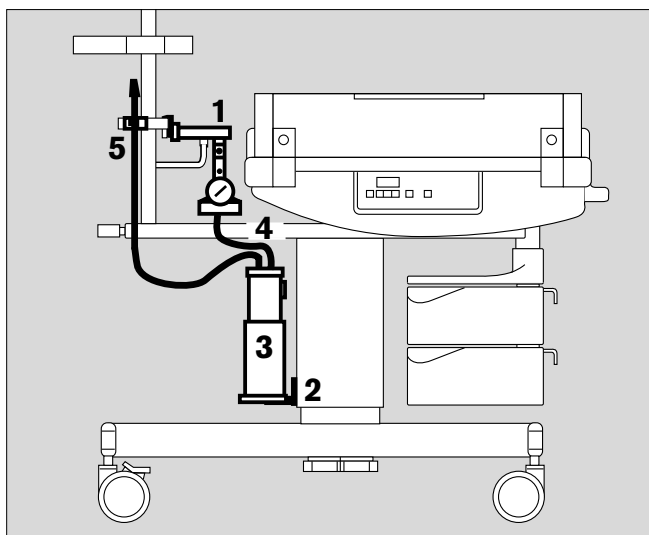

Ejector fitted to resting surface

- Attach the holder using the mounting pin:

Device with height adjustment

6 screw the holder to the column but keep the bottle holder clear of the swivelling area of the swivel unit.

Device with fixed column

- screw the holder to the left side of the column.

7 Attach the bottle holder to the mounting pin.

8 Connect the secretion jar to the ejector using the hose.

9 Attach the aspiration hose and clip into the hose holder.

- Screw on the connecting hose and insert the probe into the terminal unit of the medical gas pipeline system (in parking position).

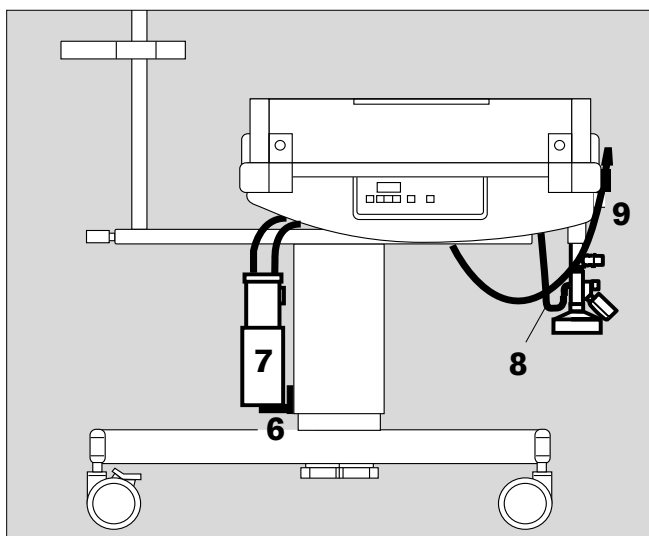

Preparing the stand

Shelf

The unit is equipped with one shelf:

Proceed as follows to fit another, optional shelf:

- Loosen bolts at existing shelf. Change height of shelf as required and tighten bolts again.
- Insert second shelf at desired height and tighten bolts.

Make sure that the shelf is firmly positioned.

Fitting rails to shelf, optional:

- Screw rail to the left and/or right of the shelf.
- Deposit auxiliary equipment on shelves and rails.
Maximum load per shelf: 20 kg.

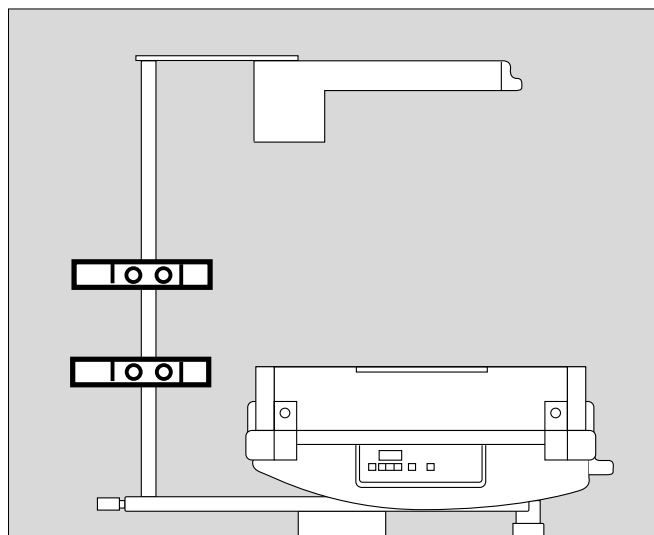

Compact rail

To accommodate auxiliary equipment, e. g. O₂ flowmeter, O₂ monitor.

- Attach compact rail to one column of the stand at required height.

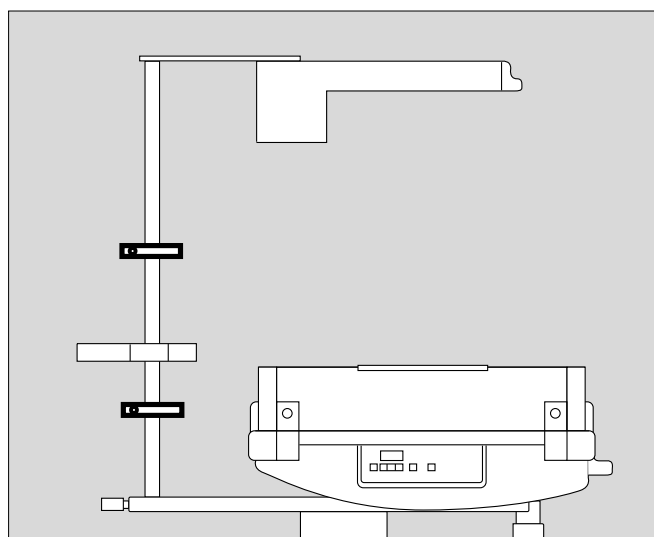

Swivel table

For small parts, max. load 3 kg.

- Push jaw of swivel table onto one column of the stand and tighten tommy screw.
- Make sure to keep swivel range clear.

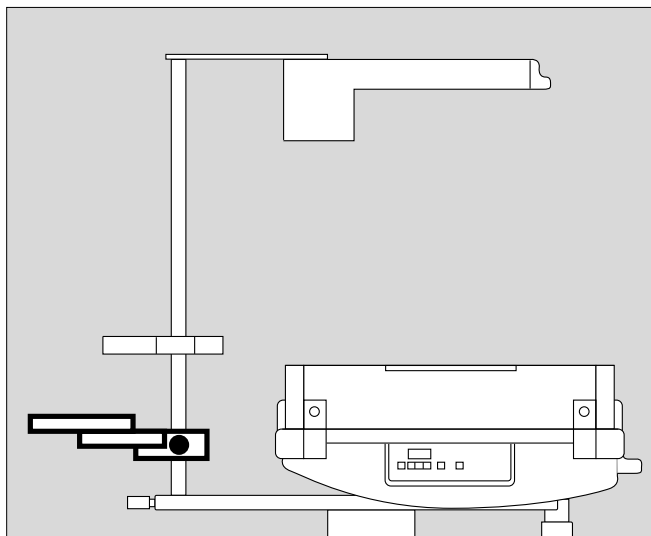

Preparing accessories for oxygen therapy

Oxygen flowmeter

- Prepare flowmeter in accordance with the relevant Instructions for Use.

Attaching the flowmeter to the compact rail:

- 1 Press the slider all the way down, hook the flowmeter to the compact rail and release the slider.
- 2 Screw on the oxygen connecting hose.
- 3 Insert the probe of the connecting hose to the socket of oxygen, and press it all the way in.

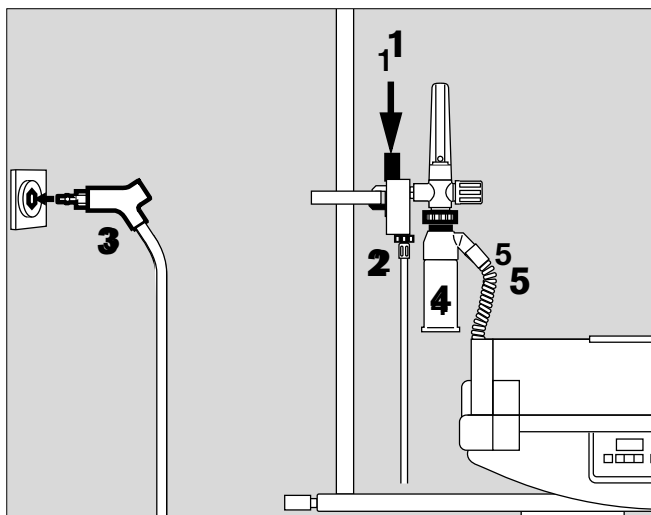

Nebulizer

- Prepare nebulizer in accordance with the relevant Instructions for Use.
- 4 Screw the nebulizer tight onto the flowmeter.
 - 5 Clip the hose onto the bushing of the nebulizer.

Oxygen distributor

Different versions are available either for connection to a pipeline system or an oxygen cylinder.

- Suspend the oxygen distributor from the standard rail.
- Connect the oxygen supply.
- Connect the oxygen load.

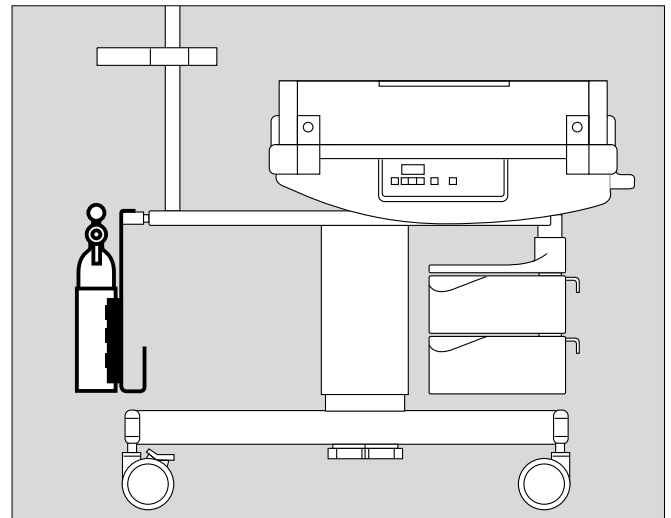

Oxygen monitor, e. g. Dräger Oxydig

- Fasten Oxydig onto the compact rail, with its holder.
Turn Oxydig such that the control panel of the measurement unit faces the front.
- Place the oxygen sensor in the cot.
Feed the cable through the flexible hose seals on the front side. Plug the sensor's plug into the measurement unit.
- Prepare and use Oxydig in accordance with the relevant Instructions for Use.

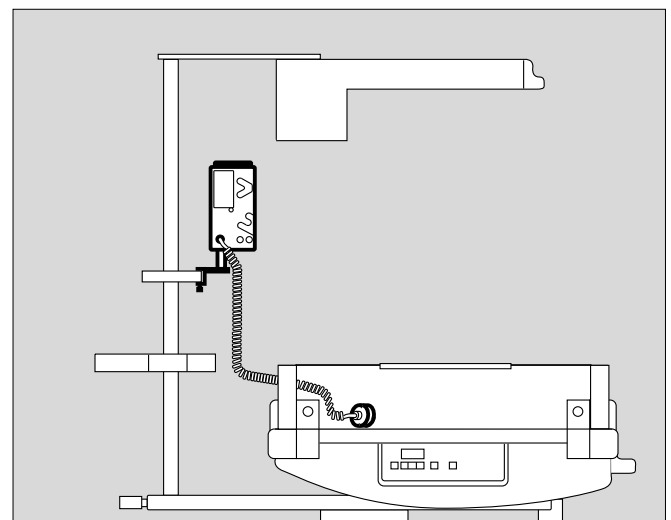

Observe stability

The unit is nontilting in accordance with IEC regulations.

The following restrictions are applicable for accommodation of accessories:

- **Be sure not to exceed 30 kg maximum load-bearing capacity of the stand.**
- If accessories which swivel to the front are positioned on a column of the stand, e. g. on a swivel table, the **maximum load** at this column is **5 kg**.

Preparing Cot Panels

The cot is surrounded by two side panels and two end panels, which can be opened independently of each other. The end panels have flexible hose seals.

Fitting the panels

- 1 Insert lower pins into the left- and right-hand guide grooves.
 - Place the panels in an upward position.
- 2 Press the panel down firmly, until the pins lock into position and lie in the grooves.
 - Tilt the panel into a vertical position, and drop it into the locking position.

- Fit all four panels.

Make sure the panels are seated correctly!

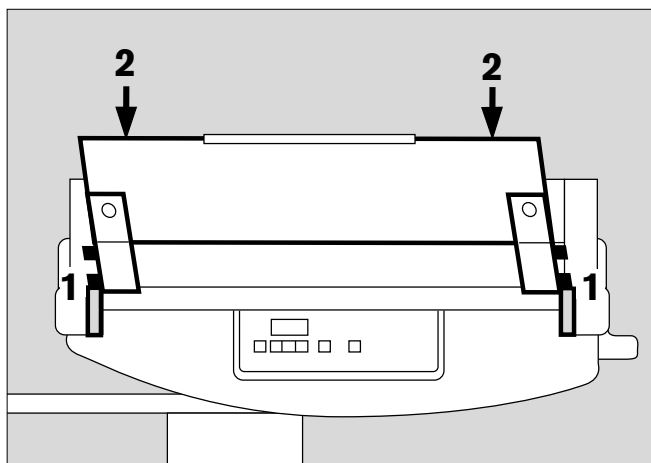

To open:

- Lift the panel all the way up, until the upper pins leave the guide groove, then fold down the panel.

Recommendation:

In order to prevent the patient from falling out when the side panels are open, **fit inner panels:**

- Insert pins in tapered holes and press down slightly until the inner panel is firmly seated.

With lively children, the optional inner walls should also be used even when the side panels are closed.

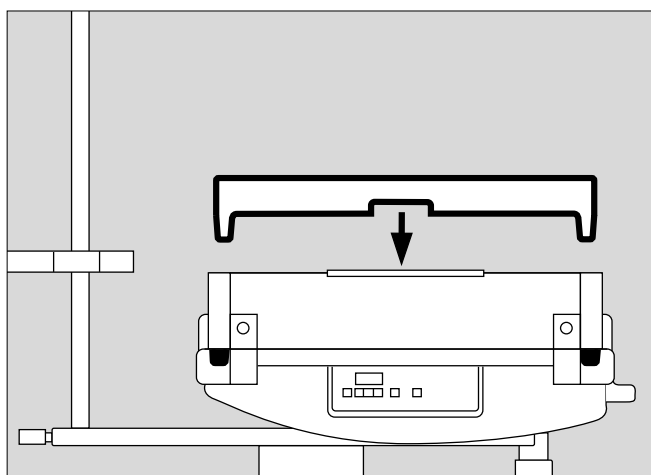

Fitting the holder for breathing tubes

- Place the tube holder into the hole on the left end panel.

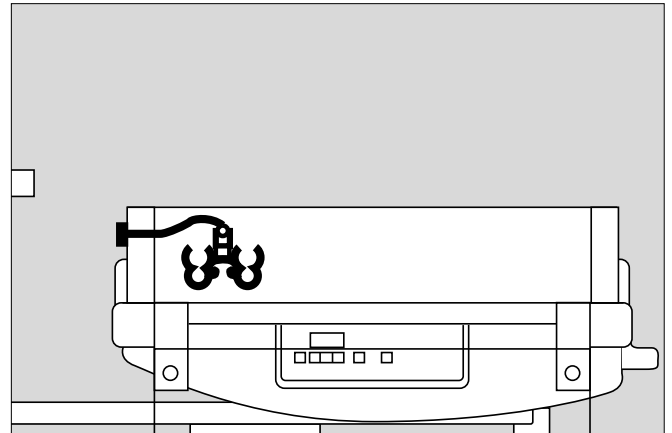

Mattress

- Select mattress type:
 - Operation **with** mattress heating:
Gel mattress 2 M 20 827, for ideal heat conduction.
 - Operation **without** mattress heating:
Foam rubber mattress 2 M 21 012, for ideal heat insulation.

Do not swap mattresses!

- Place the mattress in the cot and cover it with a cloth.

Tilting the resting surface

- 1 Pull the unlocking handle toward the front.

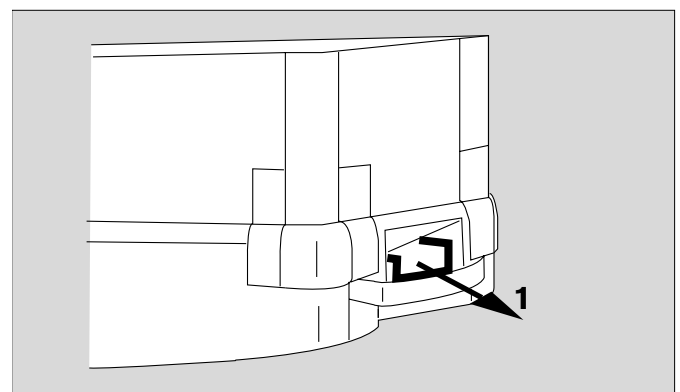

- 2 Push down handle = head-up position.
Pull up handle = head-down position.

- Release the unlocking handle; the resting surface locks into position.

The resting surface can be tilted in gradual steps.

Maximum tilting position:

- head-up position: 20°
- head-down position: 15°

Preferred positions:

- horizontal position,
- head tilted up 10° and
- head tilted down 10°.

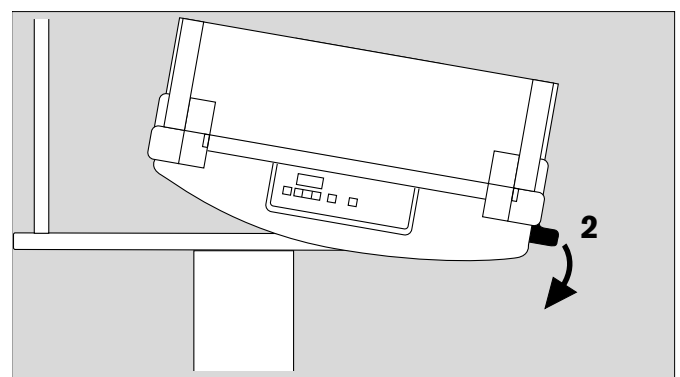

Preparing the unit for in-hospital transport

- If optional height adjustment is available, lower the unit to ultimate position.
- Slide swivel drawers inward.
- Slide swivel table inward.
- Accessory equipment which projects the unit on either side must be detached or inverted.
- Switch off heating system and unplug mains connector.
- Detach gas supply hoses from pipeline system.

For in-hospital transport of a patient in Babytherm 8000 OC:

- Open oxygen cylinder valve.
- Position the cover (accessory) to protect the child from draughts. The internal temperature can be read on the thermometer from the cover.

Immediately after transport:

- Plug in mains connector and activate heating systems.

Checking operational readiness

Prior to initial operation

- Check whether the mains voltage agrees with the values on the rating plate next to the power cable.
- Connect to mains power supply.

Prior to each use

- Was the device disinfected?
- Are the side panels locked securely into place, and closed?
- Are the side panels free of cracks and sharp edges?
- Is the right mattress in the cot:
Operation with mattress heating: gel mattress,
operation without mattress heating: foam rubber
mattress.
- Does the resting surface tilt properly, and lock
securely into position?
- Is the thermometer in the cover?
- Are the accessories and therapy equipment available,
and in proper working order?
- Is the gas supply for the devices used available and
sufficient?
- Are the cables and hoses installed securely and
properly?
Never route them over panels – they may be pinched
when folding up panels or when fitting the cover.
- Is the therapy equipment in order:
"Heat therapy" chapter, pp. 15-17 and 21, 22;
"Oxygen therapy" chapter, pp. 8, 9, 23;
"Phototherapy" chapter, p. 34.

Patient Care

Safety precautions

- Do not leave the cot when the side panels are open.
The patient could fall out!
- When folding up the side panels, do not pinch patient's body parts, tubes or any other foreign bodies, such as sheets.
- Check if all 4 panels are closed and locked securely into place. If so, the yellow panel fixtures are visible above the resting surface.

Heat Therapy

There are two heating systems for keeping the patient warm, and for warming up or cooling down:

- Mattress heating (option), see pp. 15-19,
- Radiant heater, see pp. 20-28.

Safety precautions

Monitor the core temperature of the patient constantly!

Adjust the temperature to the needs of the patient!

An increased amount of heat is directed to the patient when the mattress heating and the radiant heaters are used together.

The settings required when these heating systems are used together or separately are specified on pp. 29-31.

Mattress Heating

Safety precaution

When the mattress heating is used, the gel mattress (Part. No. 2M 20 827) must lie on the heating resting surface!

Only use the gel mattress as a heat pad for Dräger Babytherm 8000! Do not use it in Dräger cot Babytherm 4200 or other cots with heating plate temperatures above 40 °C, due to the danger of burns!

Remove all objects with sharp edges. The gel mattress can be damaged!

Do not fold the gel mattress!

To transport it, roll the gel mattress up.

Take note of the warm-up time of the gel mattress!

Wait approximately 1 hour before laying patients in the cot, after the gel mattress has had time to warm up sufficiently.



Consider the effects of additional sources of heat, such as photo-therapy radiators or radiant heaters. They increase the heat directed to the patient. Avoid sunlight!

Checking operational readiness

Prior to each use

- See if the gel mattress was disinfected and is in proper condition.
- Lay the gel mattress flat on the aluminum heating plate.

Switching unit on and activating self-test

- 1 Press the mains switch until it engages = ON.
 The microprocessor self-test checks the unit for proper functioning.
 - All LEDs lit. The numeric display shows **88.8** and an alarm tone sounds.
- 2 After approximately 2 seconds, the unit shows the standard specified temperature of 37.0 °C (display blinks).
- 3 The display alternates periodically between **SEt** and measured temperature.
- 4 Press button  or  briefly to adopt the specified value.
- 3 Display continuously indicates the measured mattress temperature.

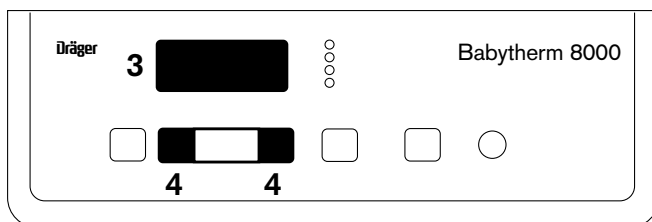
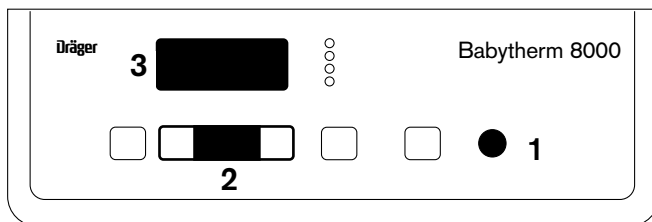

- 5 Whenever the display alternates between **Acc** and the measured temperature, and a tone sounds periodically, **the emergency storage battery is not charged sufficiently.**

The storage battery will be fully charged after approximately 30 minutes of operation. The display shows the measured temperature continuously, and the tone does not sound.

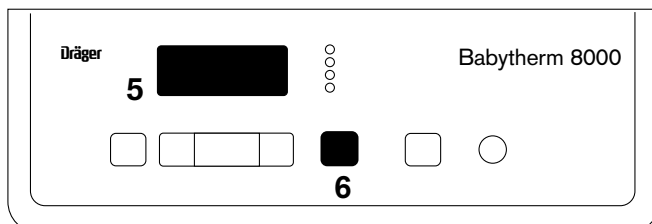

To switch off the tone:

- 6 Press the button , its yellow LED is lit.
 The tone can be switched off for 15 minutes.
- 7 The display alternates between **Err** and the measured temperature, and
- 8 the red LED **Inop** is lit – **unit inoperative**: see p. 37 for "Fault, Cause, Remedy".

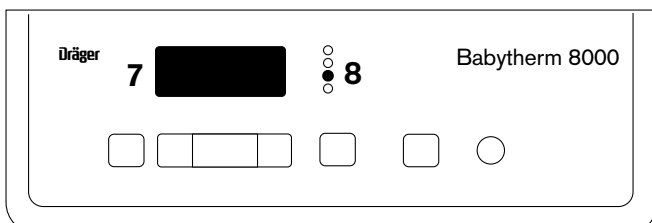

Checking LEDs, displays and alarm tone:

- 1 Press  button:

All LEDs light up for approximately 2 seconds; the numeric display shows **88.8**, and an alarm tone sounds.

Then displays and LEDs are dark and alarm tone goes off. After 2 seconds, temperature is displayed again.

The functional check is also possible during operation.

- Check at least once daily.

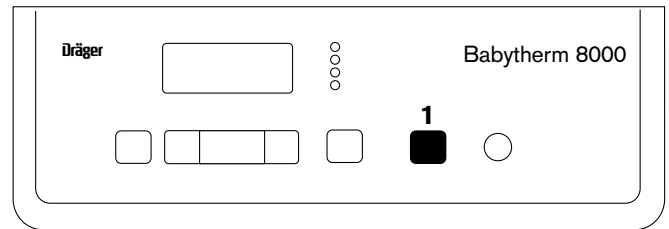

Checking mains failure alarm

- Pull down mains plug.
- 2 Red LED  lights up and constant tone sounds.
- Plug in mains plug again.
Unit continues to operate with values set **prior** to mains failure alarm.

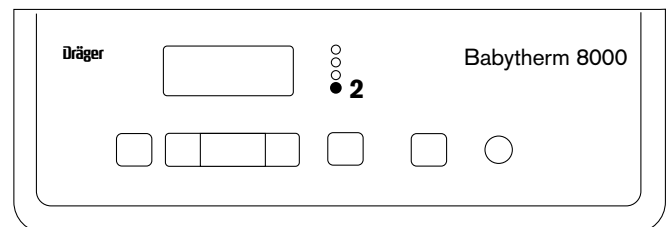

Operation

Additional external heat sources, such as a radiant heater, will increase the heat supplied to the patient and must be taken into consideration.

- Heat up mattress to 37 °C. Allow 1 hour for warm-up.
During warm-up and in standby mode, cover the gel mattress with a pillow.
- Place patient on the gel mattress, which is covered with a sheet.

When not operating a radiant heater:



- Cover patient with a blanket.

Do not switch off the heating when a child is lying on the gel mattress, as the child's temperature may be reduced.

Setting the specified temperature

The temperature can be varied in 0.1 °C steps.

Setting the temperature in the **normal range (35 °C to 37 °C):**

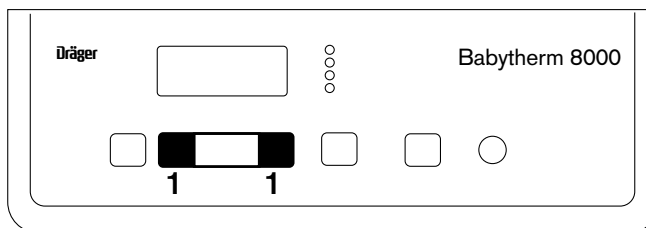

- 1 Press and hold down button  or , until the desired temperature is shown in the display.



Setting the temperature **outside** of the normal range:

- extended lower range: **30 °C to 35 °C**,
- extended upper range: **37 °C to 38.5 °C**.

Set low temperatures only if clinical required. Watch the patient continuously.

- 2 Press the unlocking button , the yellow LED in the button is lit.
- 3 Hold down the  or  key, until the desired temperature is shown in the display.

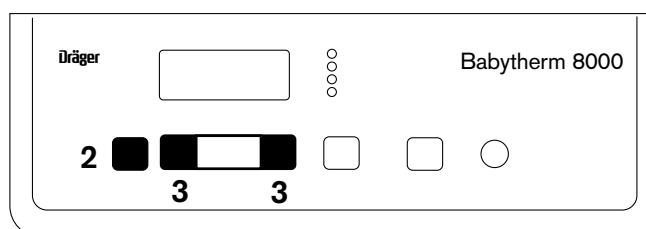

- Within 1 minute, input a temperature above 37 °C or below 35 °C.

Otherwise, the LED in the  button will go out.

The extended temperature ranges will then be locked again.

When the temperature is outside the range 5 °C to 45 °C:

- three dashes in the **bottom** of the display = the temperature is below 5 °C
- three dashes in the **top** of the display = the temperature is above 45 °C.
- See page 37 for "Fault, Cause, Remedy".

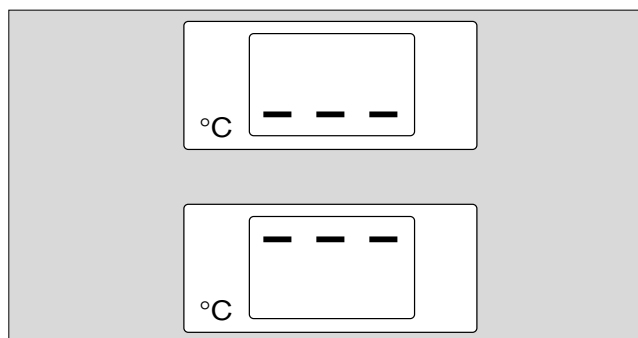

Alarms

Deviation from specified temperature

In case of deviations greater than ± 1 °C between the specified and actual mattress temperature:

- 1 The red LED ± 1 °C flashes and an intermittent tone sounds, and
- 2 the display flashes.

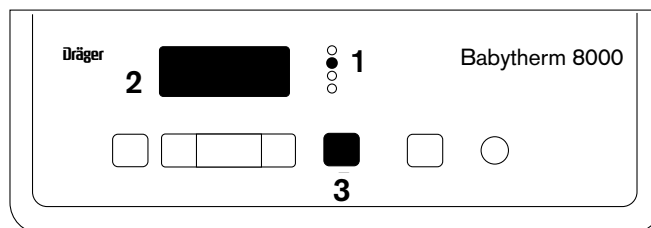

The intermittent tone can be switched off for approximately 15 minutes:

- 3 Press the  button, its yellow LED is lit.
- 1 The red LED is lit continuously.

When the actual mattress temperature has returned to a value within ± 1 °C of the specified temperature:

- 1 The red LED ± 1 °C turns off, and the intermittent tone goes off.

After the mattress heating is switched on:

- The alarm tone is suppressed for 1 hour (warm-up).
- 1 The red LED ± 1 °C is lit.
 - 3 The yellow LED in the  button is lit.

40 °C alarm

- 4 The red LED 40 °C flashes, and a continuous tone sounds.
- 5 The display flashes.

The continuous tone cannot be suppressed.
 The alarm stops automatically when the temperature decreases.

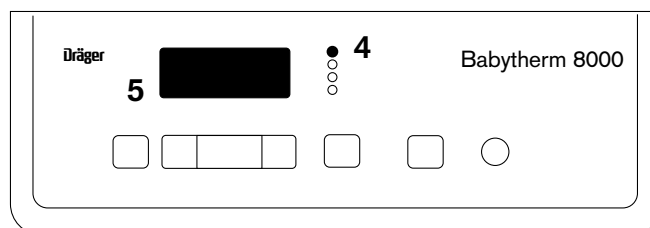

Shut-down

Only for processing when changing patients.

- Press the power switch all the way = OFF.

Then:

- Disconnect from mains power supply.
 Do this in the specified sequence. Otherwise, the mains failure alarm will be activated.

Radiant Heater

Safety precautions

Do not put anything on top of the radiant heater.

Ventilation may be blocked and the radiant heater and the object placed there may be damaged.

Do not touch top of radiant heater or protective screen. Danger of burns.

Do not use flammable detergents or medicaments whilst in operation. Danger of fire.

Any additional external heat sources, such as a photo-therapy lamp or heated mattress, will increase the heat supplied to the patient and must be taken into consideration.

Keep out of direct sunlight.

Do not place medicaments and infusion solutions in the heated area.

Do not use skin control on children subject to shock.

The skin temperature is distinctly lower than normal. These children would become overheated if the skin temperature control system was used.

With children in state of shock – set heater to »Man« operating mode and take the core temperature every 15 minutes.

Do not use skin temperature control on infants with a high temperature. Their skin temperature is significantly higher than normal so that controlling skin temperature would lead to hypothermia.

Babytherm's measuring functions must undergo regular technical checks.

See section on "Maintenance Intervals", page 36.

Checking operational readiness

Prior to each use

- Check the validity of the calibration seal on the front of the heater and on the skin temperature sensor (only required in Germany).

1 Push mains switch in – as far it will go = ON.

The microprocessor self-test checks the unit for proper functioning.

All displays are lit for about 1 second.

All numeric displays show **88.8**.

An alarm tone sounds.

Then the heater switches to »Man« operating mode (manual setting of heat output).

2 If **Err** is displayed = Error, see page 38.

3 On the display for heat level 5 LED flash = heat level 5.

4 Press button or button briefly:

Heat level 5 is set.

If the buttons are kept pressed, the heat level changes.

5 Press button: to check temperature measurement, a reference temperature is simulated.

6 Temperatur display: **36 °C** ($\pm 0,1$ °C).

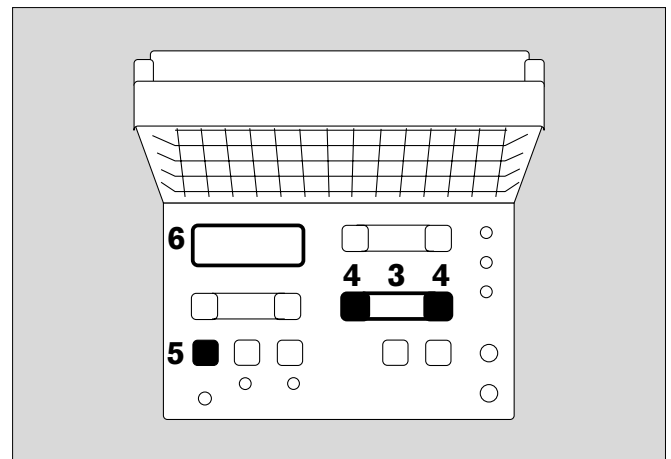
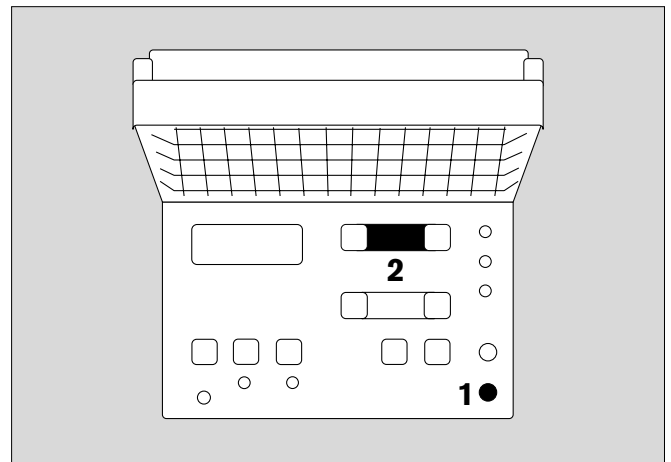

Checking mains failure alarm and NiCd battery

- Disconnect from mains power supply.

7 Red LED is lit. Intermittent sound given at a constant volume for at least 30 seconds.

If the volume decreases too soon:

- Connect the heater to the mains and leave switched on for 24 hours; the battery will be charged.
- Repeat test.

In the case of mains failure or if the unit has been inadvertently disconnected, the set values remain stored for 5 minutes.

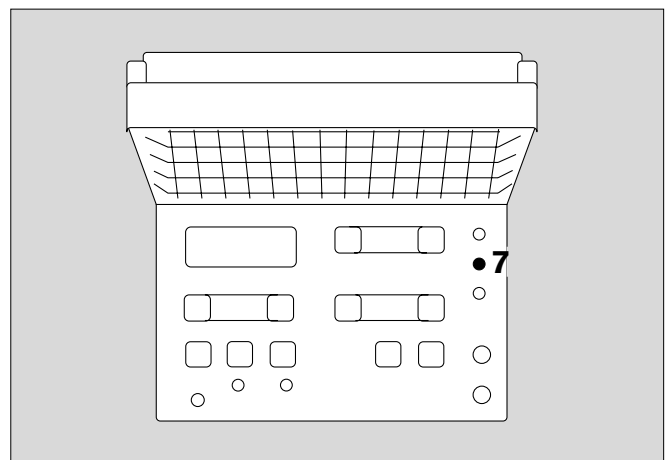

Heat Therapy
Radiant Heater
Operational readiness
Heat output manually

Checking lighting

- 1 Press ☀ button:
The bed area is illuminated.
- 1 Press ☀ button again:
The light goes out.
- 2 Push mains switch in fully = OFF.

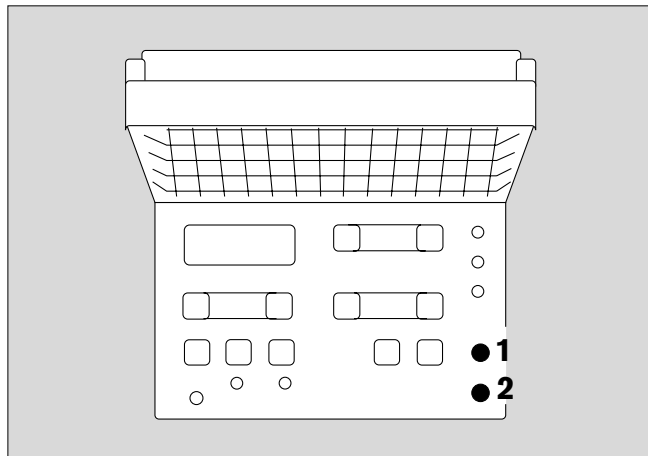

Setting heat output manually

in »Man« operating mode
for instance, during short-term treatment, for children in shock or when the skin temperature control system cannot be used.



The radiant heater gives a pre-set heat output, which is not dependent on the body temperature of the child.

The heater must not be left unattended.

The child's core temperature must be measured regularly.

A warning sound is given every 15 minutes after heating level 6 has been set as a reminder that the core temperature must be monitored continuously while the radiant heater is operating at increased heat output (3 brief sounds at intervals).

This reminder must be acknowledged by pressing the  button. (For heat levels below level 5 no reminder is given).

- 3 Push mains switch in – as far it will go = ON.
Wait for self-test. Thereafter, the heater switches to »Man« operating mode.
- 4 The green LED in the button  is lit.
- 5 On the display for heat level 5 green LEDs flash = heat level 5.
This setting can be used as a standby setting when a birth is expected to warm the bed surface.
- 6 Briefly press  button or  button: the green LED segments stay continuously lit.

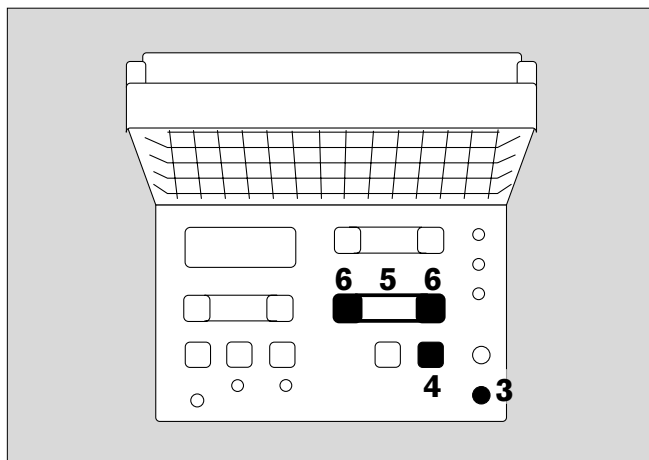



Warming-up time required

Ready for use after 25 minutes.

- Warm up in »Man« operating mode, at heat level 5.

To adjust setting:

- 1 Keep  button or  button pressed; the heat level can be changed in stages. Each green LED segment represents a heat change of about 10 %.
- 2 The yellow LED  is lit, or flashes in step with the heat pulses.

The core temperature must be measured regularly.

From heat level 6 the heater requests measurement every 15 minutes.

- 3 Acknowledge with  button.

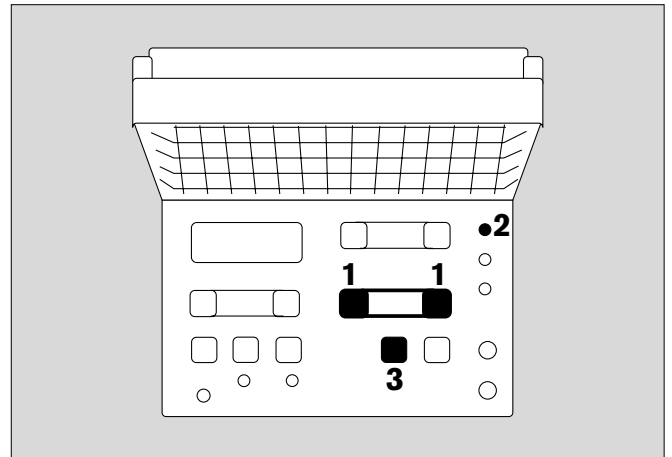



If a skin temperature sensor is connected or in place, a temperature is indicated, though skin temperature control is not taking place.

Using skin temperature control

In this operating mode the infant's skin temperature is regulated by the set value selected. The sensor which is attached measures the skin temperature. If the skin temperature is lower than the value set, the output of the radiant heater is increased; if the skin temperature is higher, the output of the heater decreased.

Therefore:

-  **Do not use on children in shock.**
The skin temperature of these children is lower than normal so that they would become overheated if the skin temperature control system was used.
Setting heat output manually, page 22.
-  **Do not use on children with high temperatures**
Their skin temperature is significantly higher than normal so that controlling skin temperature would lead to hypothermia. To check the set value or set maximum heat output, see page 22.

Connect skin temperature sensor

When using the disk-shaped temperature sensor:

- Fix double-sided adhesive ring to skin temperature sensor.
- Remove backing from adhesive ring and stick it concentrically onto the outer ring of the sensor.
- Remove protective foil from other side of adhesive ring and stick the sensor to an appropriate area of skin with the ring.

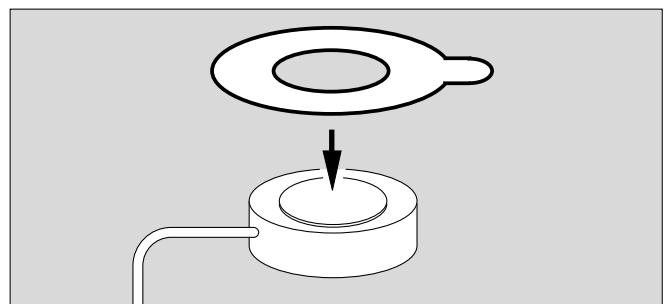

When using the pin-shaped temperature sensor:

- Fix tip of sensor with suitable adhesive tape, e. g. 3M-Microfoam 25 mm/1528-1 to an appropriate area of the skin.

Heat Therapy
Radiant Heater
Skin temperature control

If the child is lying on its back:

- Fix sensor on the abdomen in the liver region.

If the child is lying on its front:

- Fix sensor on the back, preferably in the kidney region.

Never fix the sensor underneath the child. If this was done the core temperature would be measured and used for control, not the skin temperature.

- Anchor sensor cable with with a plaster.
- **At regular intervals check that skin temperature sensor is properly fixed.**
If a skin temperature sensor gets detached it will measure air temperature and so the child can become overheated.
- **Do not use the skin temperature sensor to take the rectal temperature.**
- When using skin temperature control do not position the sensor rectally, as the core temperature, not the skin temperature, would then be measured and controlled.

When using the disk-shaped temperature sensor:

- 1 Connect sensor plug to socket.

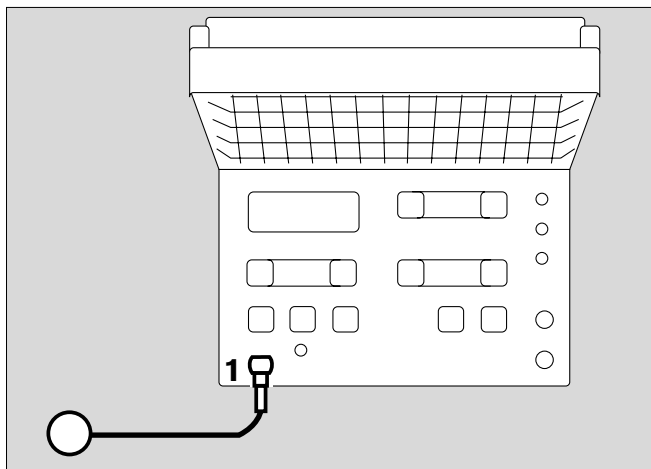

When using the pin-shaped temperature sensor:

- 2 Connect the cable of the adapter with the cable of the sensor and
- 3 connect the adapter plug to socket.

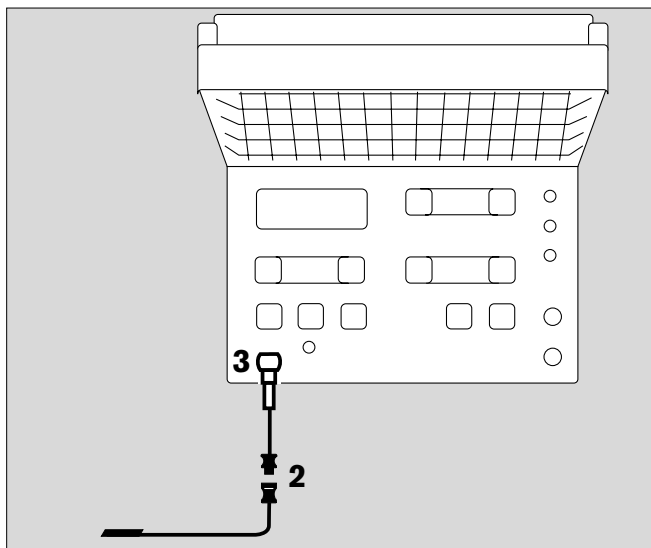

- 1 Push mains switch in – as far it will go = ON.
After self-testing the heater switches to »Man« operating mode.

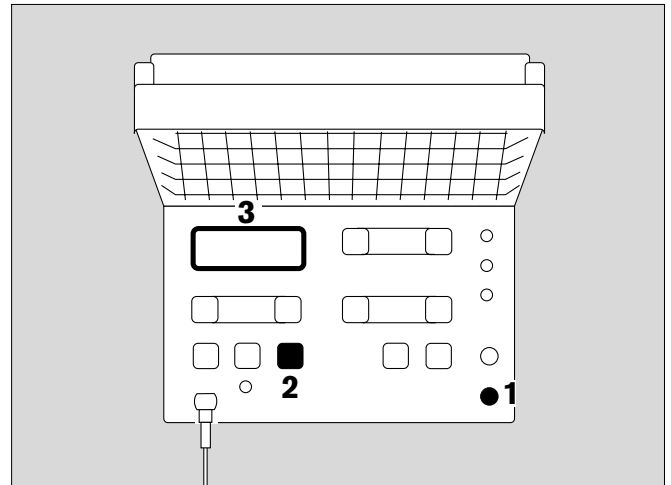

If the temperature is outside the measuring range of 33 °C to 38 °C:

- 3 dashes at the bottom of the display = temperature below 33 °C.
- 3 dashes at the top of the display = temperature above 38 °C.
- See section on "Fault, Cause, Remedy", page 38.

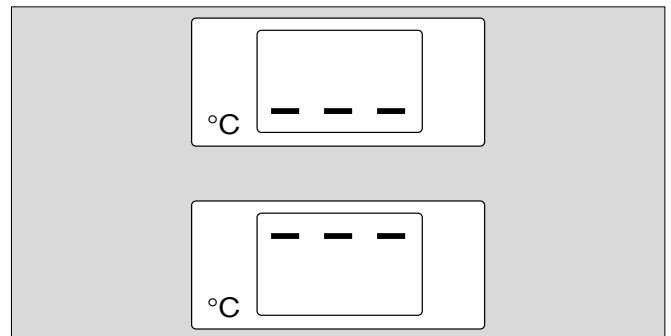



The skin temperature sensor must be allowed to adjust to the temperature of the child for at least 5 minutes.

When the value displayed remains constant:

- 2 Press  button: skin temperature control is operating, the green LED in the button is lit.
- 3 Skin temperature is displayed.

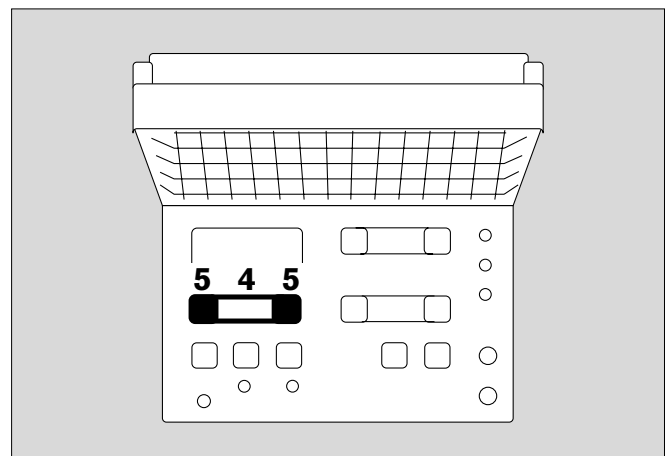

Initially the heater offers the standard temperature of 36.3 °C.

- 4 Display **36.3 °C** flashes.
- 5 Press  button or  button briefly.
This temperature is accepted, the display remains continuously lit.



Heat Therapy
Radiant Heater
Skin temperature control

The set temperature can be changed in 0.1 °C stages:

- 1 Keep  button or  button pressed until the required temperature appears in the display
- 2 The yellow LED  is lit or flashes in step with the control pulse (functional display of heating).

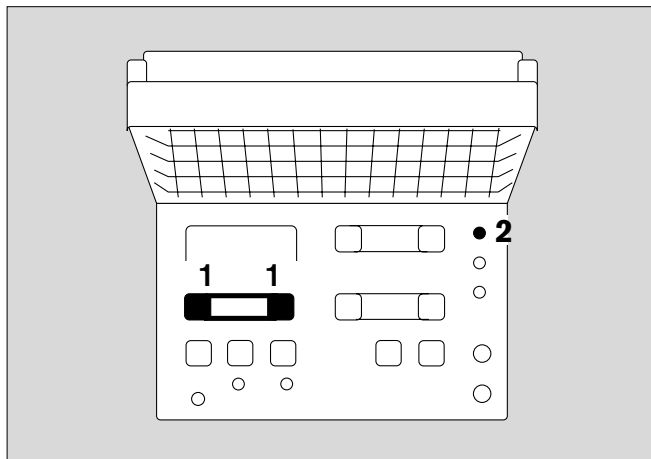

To test functioning during operation:

- 3 Press  button.
- 4 The simulated temperature value must be **36 °C** (± 0.1 °C) (function test).

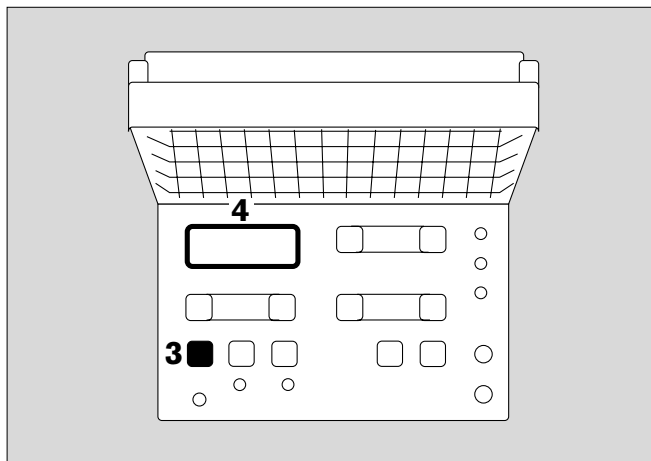

If the sensor plug is disconnected or the sensor is faulty:

- 5 Three flashing dashes in the middle of the display,
 - 6 the red alarm LED **Sensor** is lit.
- A continuous sound is given (cannot be switched off), then:
re-connect sensor plug immediately or replace skin temperature sensor.

If the fault cannot be immediately eliminated:

- switch to »Man« operating mode.

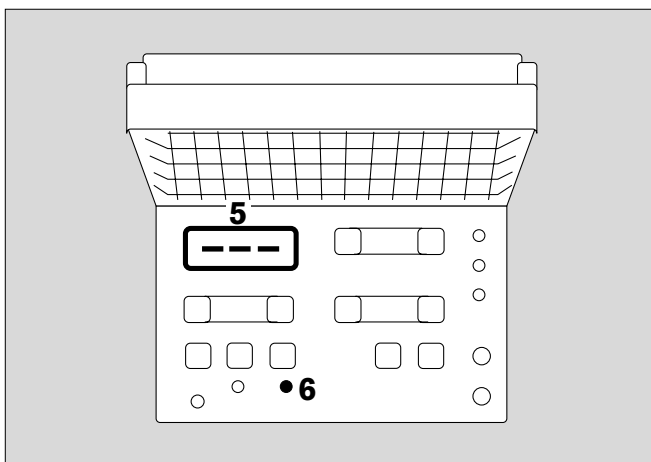

Stabilisation time

Deviations between the set value for skin temperature and the measured value stabilise over **periods of about 5 to 15 minutes.**

Children's skin temperature changes frequently, for instance as a result of food intake or treatment procedures on the child. Deviations of a tenth of a degree are normal.

Therefore:

Only change the set value for skin temperature if the core temperature needs to be corrected.

For deviations greater than $\pm 0.5\text{ }^{\circ}\text{C}$ between the set value for skin temperature and the measured value for skin temperature:

- 1 red LED $\pm 0.5\text{ }^{\circ}\text{C}$ flashes, an intermittent sound commences.

The intermittent sound can be suppressed for about 10 minutes:

- 2 Press  button, with yellow LED lit.

If the measured value for skin temperature is again within the range of $\pm 0.5\text{ }^{\circ}\text{C}$ of set value, the red LED $\pm 0.5\text{ }^{\circ}\text{C}$ goes out and the intermittent sound ceases.

When the skin temperature sensor has to be removed from the skin temporarily, first switch over to »Man« operating mode:

- 3 Press  button with green LED lit; »Man« operating mode operates.

Using timer

for periods of up to 100 minutes.

If, for example, the timer was started at the moment of birth, three short sounds are given after 1 minute, after 5 minutes and after 10 minutes, as a reminder to update the APGAR score.

To start timer:

- 4 Press  button.

To stop:

- 5 Press  button.

To reset display:

- 5 Press  button a second time.

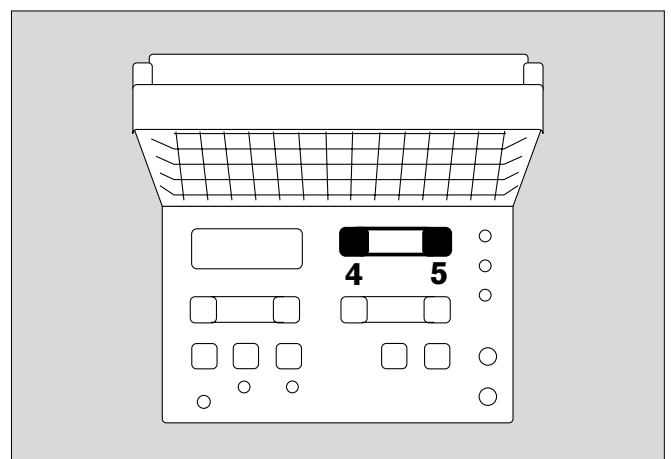
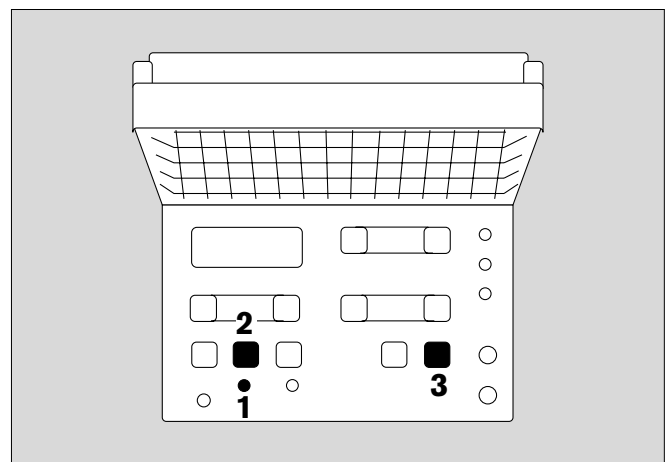

Positioning halogen lamp

to target lighting

- 1 Push loops towards front panel:
the light beam tilts backwards.

Pull loops:
the light beam tilts forwards.

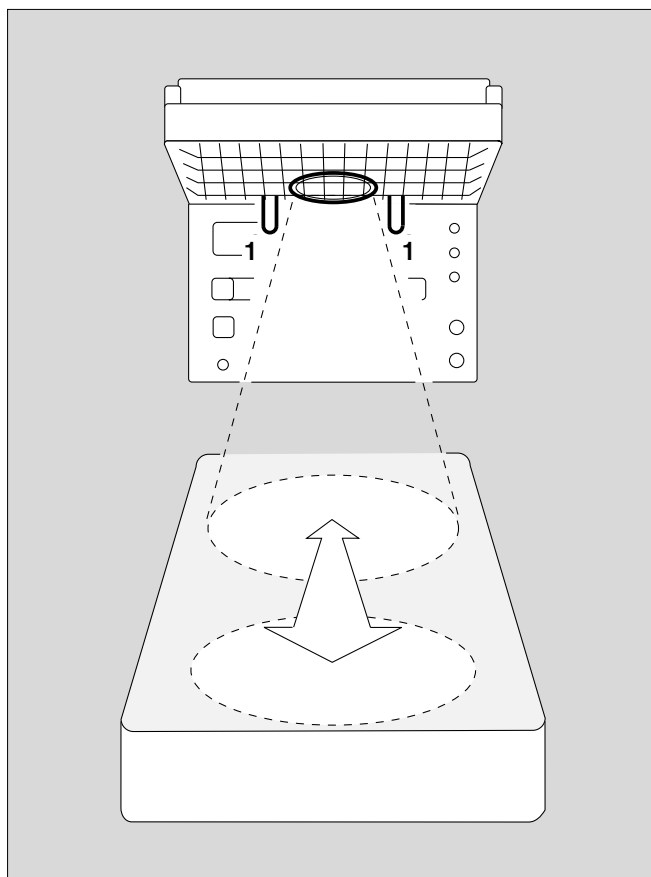

Shut-down

First:

- Push mains switch in as far as it will go = OFF.

Then:

- Disconnect from mains power supply.
Do this in the specified sequence. Otherwise, the
mains failure alarm will be activated.

Allow approximately 30 minutes for radiant heater to cool
down prior to cleaning and disinfection.

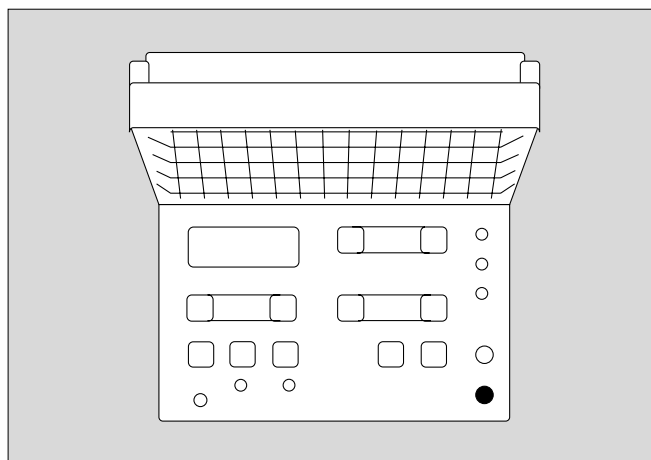

Notes on Settings of the Mattress and Radiant Heater Heating Systems

Using the mattress heating with the gel mattress without the radiant heater

Monitor the core temperature of the patient constantly.

Adjust the temperature to the needs of the patient.

- Always cover patients, and/or clothe them. **Blankets, etc., obstruct the flow of heat when placed under the patient.**

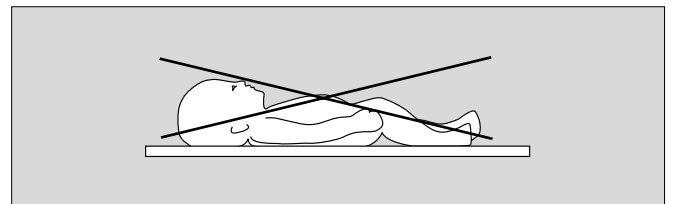
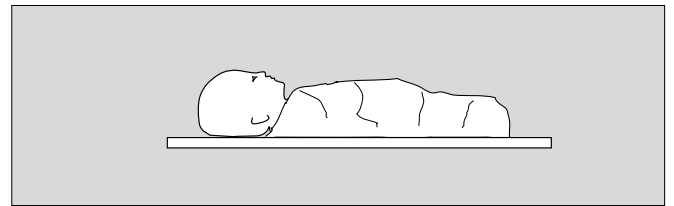

- Adding heat:
Set the temperature to, e. g. 38.5 °C.

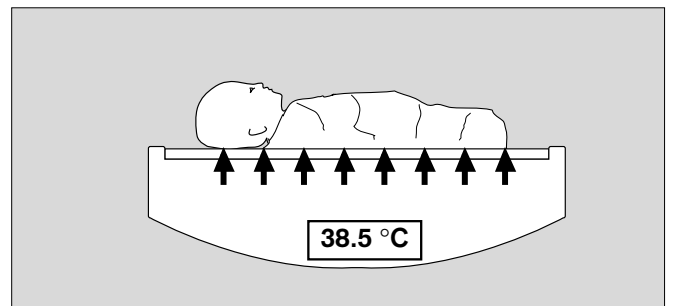

- Heat neither added nor dissipated:
Set the temperature to 37 °C.

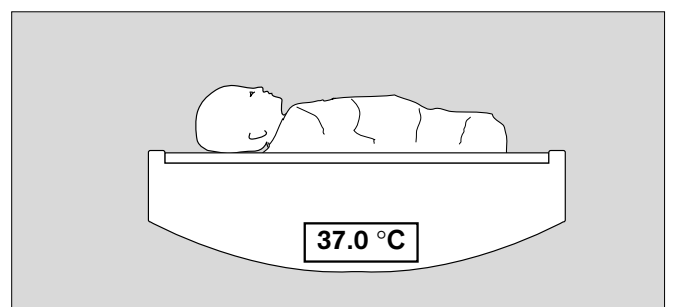

- Cooling the patient:
Set the temperature to 36 °C.

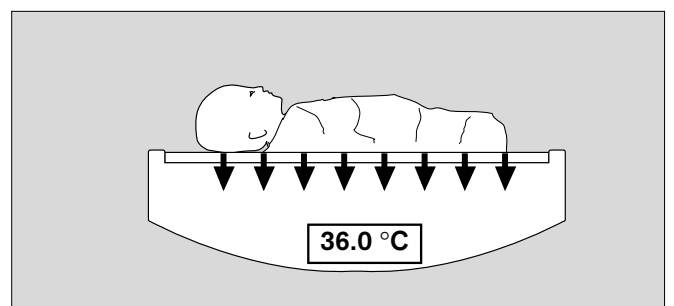

Using radiant heater

Monitor the core temperature of the patient constantly.

Adjust the temperature to the needs of the patient.

- Do not use the cover. Otherwise, the radiant heater will have no effect.

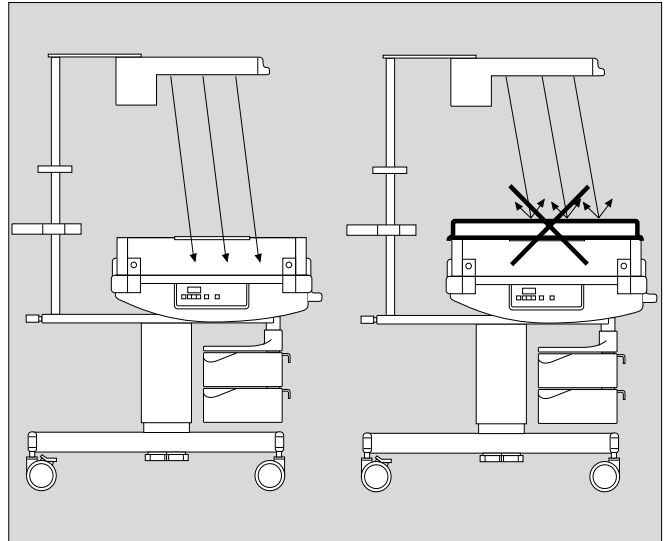

- Do not cover or clothe the patient.

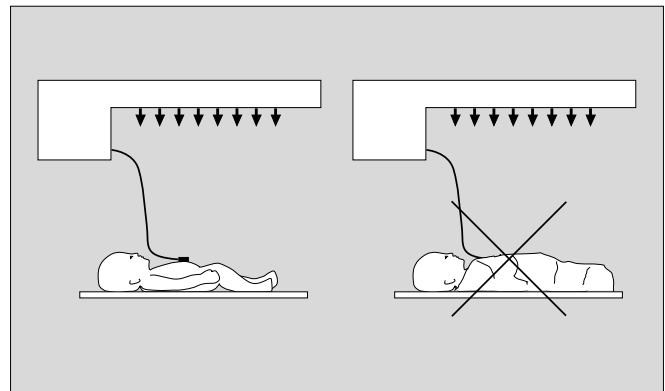

Using the radiant heater without mattress heating

1 Use a foam rubber mattress.

Do not use the gel mattress without the mattress heating, or when the mattress heating is switched off.

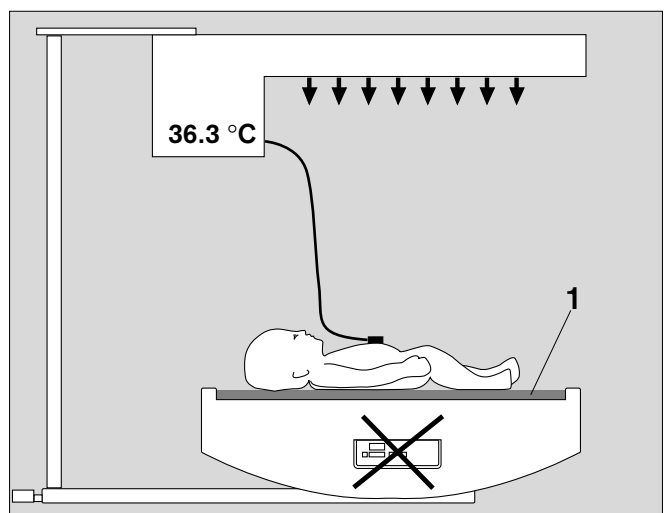

Using radiant heater and mattress heating with the gel mattress

- Adding heat from below, in addition to the radiant heater = normal use:
Set the mattress heating temperature to, e. g., 38 °C and set the skin temperature at the radiant heater to, e. g., 36.3 °C.

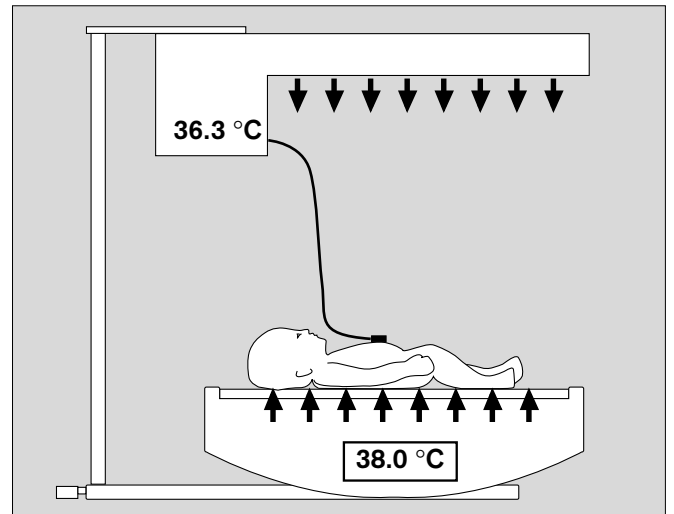

- Achieving a neutral balance:
Set the mattress heating temperature to 37 °C and set the skin temperature at the radiant heater to, e. g., 36.3 °C.

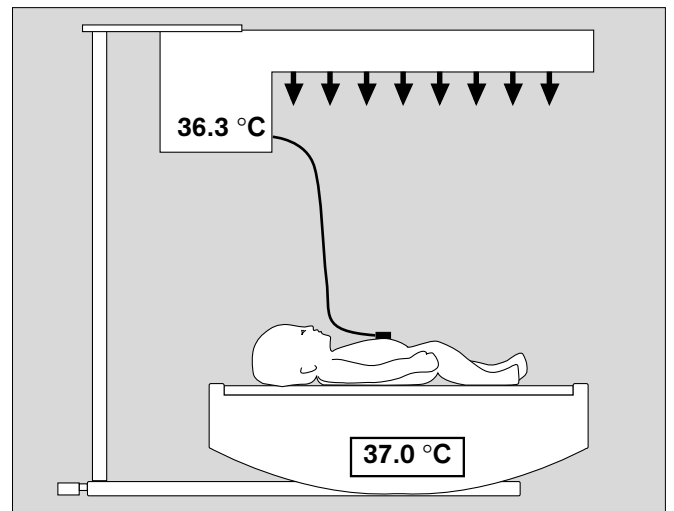

- Cooling the patient from below:
Set the mattress heating temperature to, e. g., 36 °C and set the skin temperature at the radiant heater to, e. g., 36.3 °C.

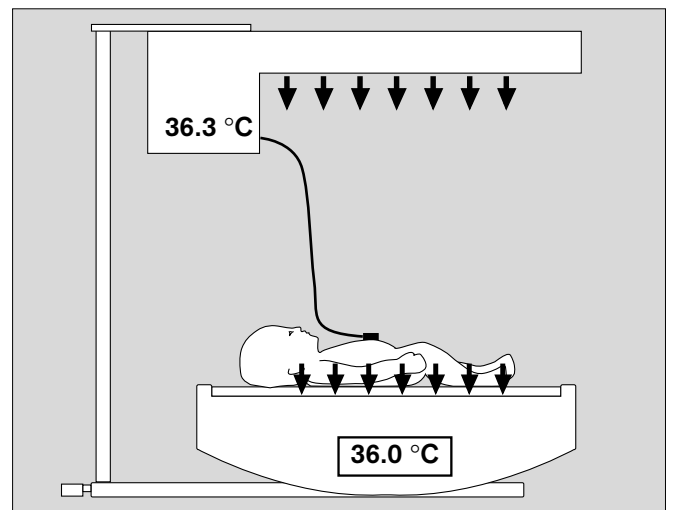

Oxygen Therapy

Safety precautions

Increased danger when using oxygen

- Avoid open fire and burning cigarettes!
Textiles, plastics and oils are easily inflammable in an oxygen-rich atmosphere, and burn with great intensity.
- Keep oxygen fittings and gaskets free from oil and grease.
- Open valves slowly.
- Do not use Babytherm 8000 OC in the presence of inflammable anaesthetic gases or disinfectants.
- Do not use or store inflammable liquids, such as alcohol, ether or acetone, in Babytherm 8000 OC.
- Do not operate electric equipment under the cover, with the exception of equipment approved for operating at hazardous locations.

Physiological dangers from oxygen

Only apply oxygen enrichment when prescribed by a physician. Only carry out in accordance with arterially measured oxygen partial pressure in blood of patient. Otherwise there is danger of hyperoxaemia (harm to the eyes) or hypoxaemia (harm to the brain).

During therapy, monitor the oxygen concentration, e. g., with Dräger Oxydig.

Increased noise level

The noise level may be greater for the patient, when the hood is used, and when pressurized gas is introduced.

Administering oxygen with hood

- 1 Insert sensor of Oxydig with adpater ring in cup packing with star-shaped cut-out. Insert plug into measuring unit.
- 2 Connect the O₂ supply hose to hood.
- Position the patient on his back.
- 3 Place the hood over the head in such manner that his bottom rests on the even surface of the mattress. Do not seal the collar area of the hood.
- 4 Adjust O₂ supply between 0.5 to 4 L/min at the flow-control valve.
- 5 Monitor O₂ concentration with Oxydig!

Following operation

- Lift hood off patient's head.
- Close valve on the O₂ flowmeter = close in clockwise direction.
- Remove therapy equipment and process, see page 35.

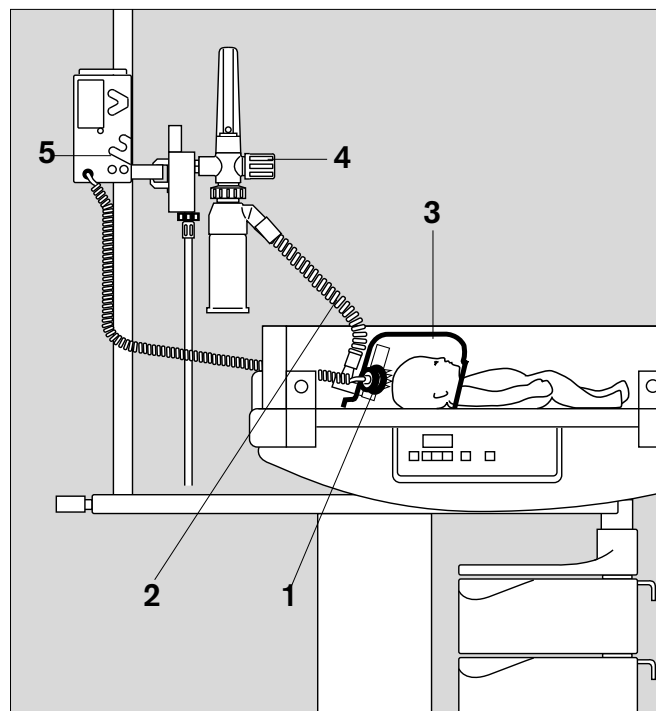

Bronchial aspiration

- Use the bronchial aspirator in accordance with the relevant Instructions for Use.

Babylog 2000

for resuscitation

- Place Babylog 2000 on table surface between columns.
- Prepare and use Babylog 2000 in accordance with the relevant Instructions for Use.

Phototherapy

Only administer phototherapy when using the radiant heater simultaneously.

Otherwise the naked child could catch a chill!

- Roll the stand under the trolley frame of Babytherm 8000 OC.
- Position the lamp at an angle.
- Adjust the height of the phototherapy unit:
Photo-Therapy Unit 8000:
The underside of the body of the lamp must be **at least 0.4 meter** away from the patient.
Photo-Therapy 4000:
The underside of the body of the lamp must be **at least 0.3 meter** away from the patient.

Position the lamp such that the heat radiation reaches the patient unencumbered.

- Operate the phototherapy unit in accordance with the relevant Instructions for Use.

If the radiant heater is used in »Man« mode:

- Set the heat approximately three levels lower than for use without phototherapy.

The phototherapy lamp provides additional heat.

Monitor the patient's core temperature.

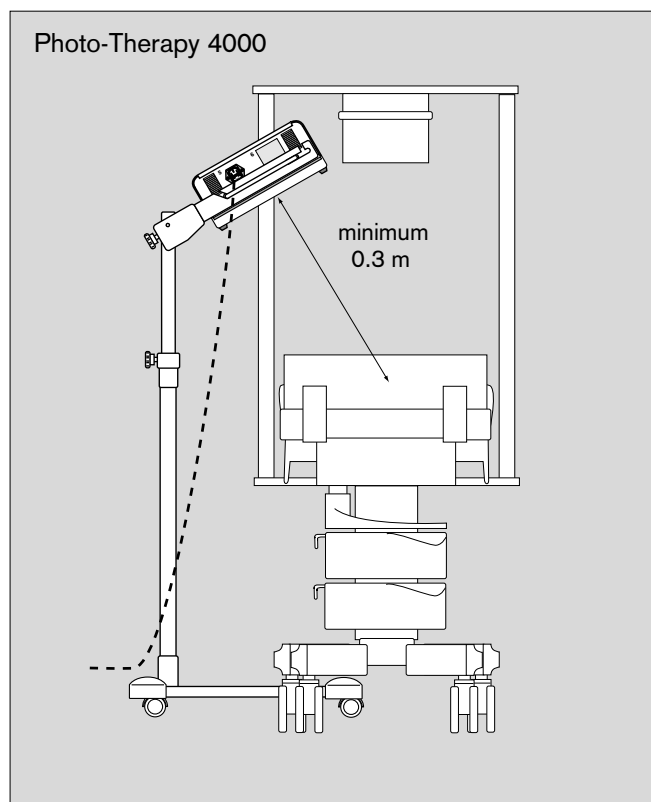

X-Raying

- Place the x-ray film cassette directly under the patient.
- Swivel the radiant heater to the side.
- Place the X-ray machine above Babytherm 8000 OC.

After taking the X-rays:

- Swivel the radiant heater back over the patient.

Care

Thoroughly clean and disinfect Babytherm 8000 OC:

- following each change of patients,
- at least once weekly.

Clean and disinfect accessories, e. g. bronchial aspirator, in accordance with separate Instructions for Use.

Stripping down

- Switch off equipment. Pull out mains plug and shut off all pressurised gases in use.
- Remove additional equipment.
- Remove mattress from resting surface. Keep gel mattress lying flat when stored.
- Remove the holder for breathing hoses.
- Take off flexible hose seals.

Cleaning/disinfecting/sterilizing

- Allow radiant heater to cool for approx. 30 minutes before disinfecting.
- Do not allow liquid to reach inside of unit or radiant heater.

Cot, inside and outside; side panels, inside and outside; resting surface; mattress; stand including everything attached to it; radiant heater surface:

- Remove visible impurities with a throw-away cloth immersed in a detergent.
- Wipe-disinfect surfaces.
- Wipe and dry with a clean, damp cloth.

**Do not clean the mattress in a washing machine.
Do not autoclave.**

Flexible hose seals:

- Wash with a detergent and rinse with clear water.
- Disinfect parts in a splash bath. Then rinse in clear water and dry;
or
- sterilize at 120 °C (glove program).
- Do not irradiate Babytherm 8000 OC with ultraviolet rays. Perspex parts could crack.

Only use the recommended cleansing and disinfecting agents! If alcohol, e. g. is used, perspex and macrolon parts could crack.

For disinfecting, use surface disinfectants. For reasons of material compatibility, use disinfectants based on

- aldehydes,
- quaternary ammonium compounds.

The following agents may damage the materials and are not suitable:

- halogen-releasing compounds,
- strong organic acids,
- oxygen-releasing compounds.

For users in Germany, we recommend that only disinfectants on the current DGHM (DGHM: German Society for Hygiene and Microbiology) list be used. The DGHM list specifies the composition of each disinfectant.

For countries in which the DGHM list is unknown, the above disinfectant types are recommended.

The following wipe disinfectants are recommended:

Bacillotox	Bode, Hamburg
Incidur	Henkel Hygiene GmbH, Düsseldorf
Gevisol	Schülke & Mayr, Norderstedt
Sekusept-Pulver	Henkel Hygiene GmbH, Düsseldorf

Follow manufacturer's instructions.

Before the next use

- Reassemble unit parts.
- Following wipe-down disinfection, operate the unit for a few hours without a patient, in order to eliminate any disinfectant residues. The temperature of the mattress heating should be 37 °C. Radiant heater operates in »Man« operation mode at heat level 5.

Before a patient is placed in the Babytherm 8000 OC:

- Set up therapy accessories.
- Check operational readiness, see p. 13.

Maintenance Intervals

The unit or its components have to be disinfected and cleaned prior to each maintenance procedure, and also before unit is returned for repair.

⚠ Disconnect from mains power supply before each maintenance procedure.

Gel mattress	Cover small cracks in the foil with adhesive tape from the repair set.
Flexible hose seals	Replace when brittle and sticky.
Temperatur measuring device (radiant heater)	Check the measurements at the same time as other technical safety checks are carried out by trained personnel.
NiCd battery for mains failure alarm (radiant heater)	to be replaced by trained service personnel after 2 years.
Time Keeper RAM	to be replaced by trained service personnel after 4 years.
Inspection and maintenance*	yearly by trained service personnel.

Disposal of NiCd batteries

- do not throw into fire, risk of explosion.
- do not force open, danger from corrosive substances.

Batteries must be disposed of as special waste:

- Follow local regulations on the disposal of waste products.

For further information contact the local authority or Environmental Control Office, or approved waste disposal contractors.

* Definitions:

Inspection	= examination of actual condition
Service	= measures to maintain specified condition
Repair	= measures to restore specified condition
Maintenance	= inspection, service, repair

Fault, Cause, Remedy

Mattress heating

Fault	Cause	Remedy
Red LED ± 1 °C flashes, actual value display flashes, intermittent tone sounds.	Measured mattress temperature deviates from specified temperature by more than ± 1 °C.	During operation with radiant heater: reduce heating output of radiant heater.
Red LED 40 °C flashes, actual value display flashes, continuous tone sounds.	Mattress temperature >40 °C	During operation with radiant heater: reduce heating output of radiant heater.
Red LED \Rightarrow lights up, continuous tone sounds.	No electrical power	Check connection to mains power supply. Check that mains power supply is present. Call DrägerService.
Red LED Inop lights up. Err appears on actual value display alternately with measured value. In the specified value display the fault code is flashing. alternately with fault code.	Malfunction	Call DrägerService.
3 flashing dashes in the middle of the actual value display.	Faulty temperature sensors	Call DrägerService.
Acc appears on actual value display alternately with measured value. Intermittent tone sounds.	The emergency storage battery is not sufficiently charged.	Operate the device for 30 minutes, Press button  , alarm tone is suppressed for 15 minutes.
In actual value display: 3 dashes bottom 3 dashes top	Mattress temperature <5 °C Mattress temperature >45 °C	Wait until mattress temperature >5 °C. Wait until mattress temperature <45 °C.

Height adjustment (optional)

Fault	Cause	Remedy
Height adjustment does not work.	The motor's over-temperature switch kicked in.	Let cool off, approximately 15 minutes.

Radiant heater

Fault	Cause	Remedy
Red LED $\pm 0,5$ °C flashes. Intermittent sound commences.	Measured skin temperature value has deviated from set value by more than ± 0.5 °C.	When measured value is below the set value: check skin temperature sensor is correctly positioned. When measured value is above the set value: measure core temperature.
Red LED Sensor is lit. Continuous sound commences.	Skin temperature sensor plug not connected. Faulty sensor	Check plug connection. Switch to »Man« operating mode, replace sensor, then switch back to »Auto« operating mode.
Red LED ⏻ is lit. Continuous sound commences.	No electrical power	Check connection to mains power Check that the two mains fuse are intact. Check that mains power supply is present. Call DrägerService.
Red LED Inop is lit. Err appears on the timer alternately with fault code. Continuous sound commences.	Malfunction	Note fault code, call DrägerService.
Lighting does not work.	Faulty halogen lamp	Have halogen lamp replaced by trained service personnel.
Inadequate heat output.	One or more infra-red radiant heaters faulty.	Have radiant heaters replaced by trained service personnel.
Reference temperature of 36 °C is outside the tolerance of ± 0.1 °C, if button  pressed.	Temperature measuring system is not functioning accurately.	Call DrägerService.
In skin temperature display: 3 dashes bottom 3 dashes top	Skin temperature <33 °C Skin temperature >38 °C	Check that the skin temperature sensor is fitted.

What is what

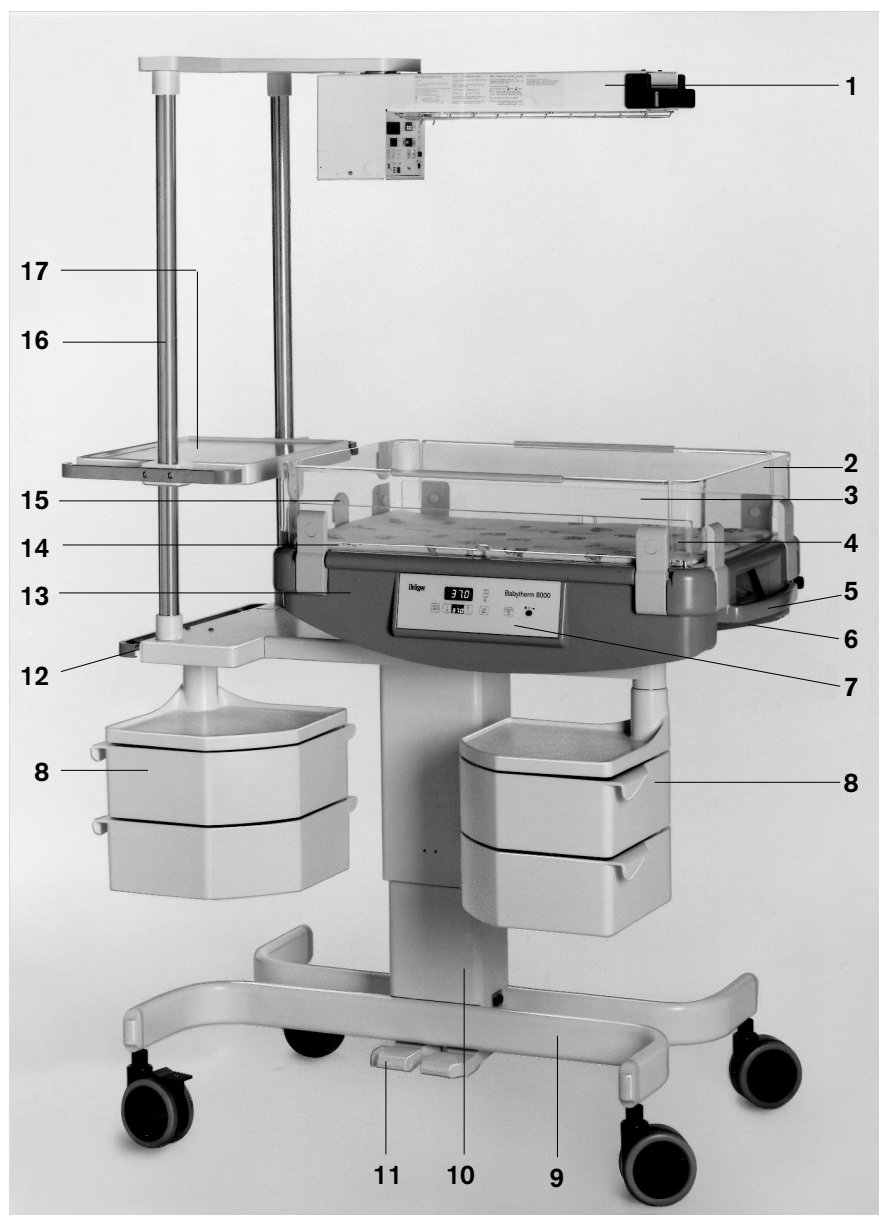

- | | | | |
|---|--|----|---|
| 1 | Radiant heater | 10 | Height adjustment, optional |
| 2 | End panel | 11 | Foot control, only with height adjustment |
| 3 | Side panel | 12 | Standard rail |
| 4 | Inner panels | 13 | Cot |
| 5 | Handle with inner unlocking handle for tilting the cot | 14 | Gel mattress for use with mattress heating; foam rubber mattress for use without mattress heating |
| 6 | Inner rail with hook for draining bag | 15 | Flexible hose seals, 3 ea. |
| 7 | Mattress heating control panel, optional | 16 | Stand |
| 8 | Left and/or right swivel unit, optional | 17 | Shelf with 2 rails |
| 9 | Trolley frame with 4 wheels, 2 of which can be locked into place | | |

Mattress heating

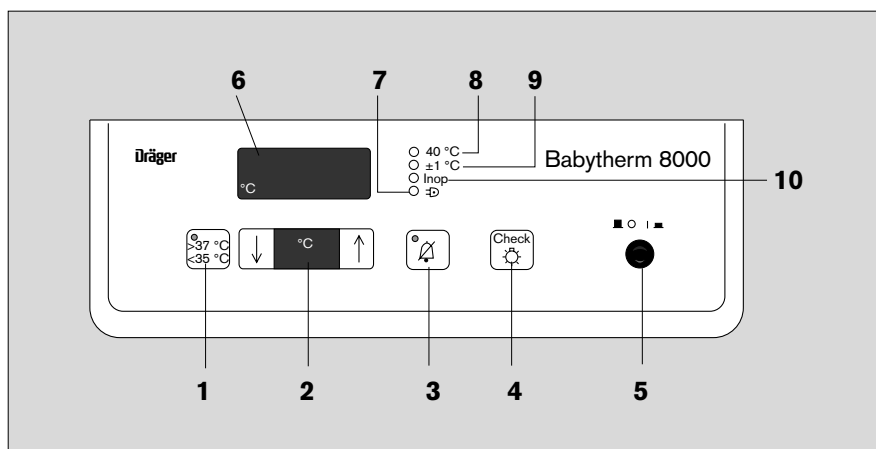

Control panel

- 1 Button for extending the specified temperature to 30 °C to 38.5 °C.
- 2 Display of specified mattress temperature; to the left of display: button for reducing the specified temperature, to the right of display: button for increasing the specified temperature.
- 3 Button for suppressing the intermittent tone for 15 minutes; The yellow LED lights up when the intermittent tone is suppressed.
- 4 Button for checking the working order of LEDs, displays and the alarm tone.
- 5 Mains switch
- 6 Display of actual measured mattress temperature.
- 7 Red LED ⚡ ; lights up in case of mains failure.
- 8 Red LED 40 °C; flashes when the measured mattress temperature exceeds 40 °C.
- 9 Red LED ± 1 °C; flashes when the measured mattress temperature deviates more than ± 1 °C from the specified value.
- 10 Red LED **Inop**; lights in case of unit malfunction.

Radiant heater

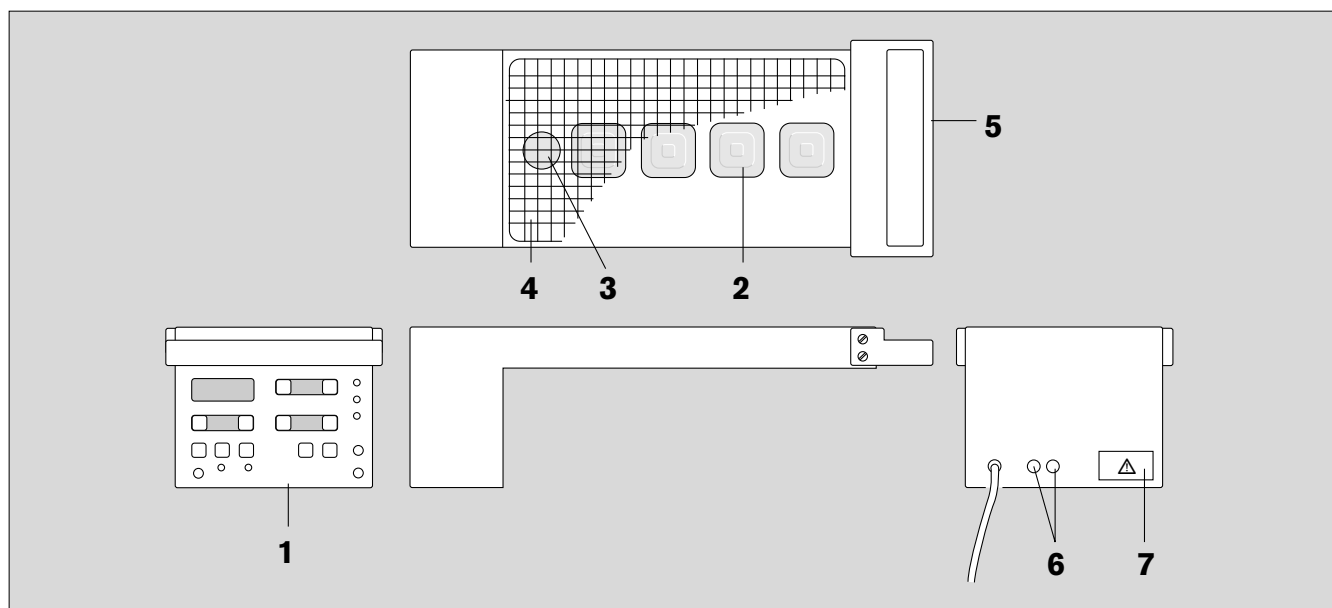

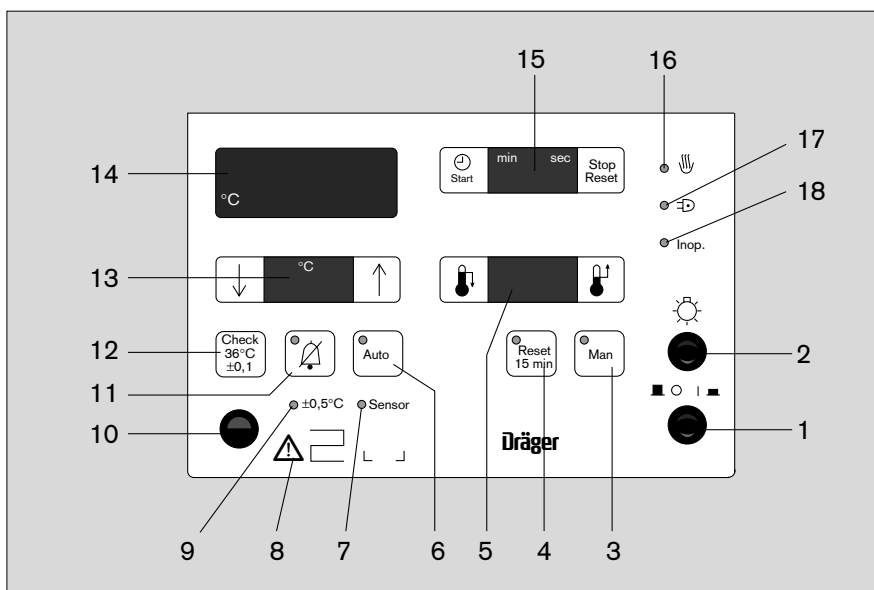

- 1 Operating panel
 - 2 Infra-red ceramic radiant heater (4ea.)
 - 3 Halogen lamp
 - 4 Protective screen
 - 5 Handle
 - 6 Fuses (2ea.)
 - 7 Rating plate
-  Follow the Instructions for Use!

Radiant heater



Operating panel

- | | |
|---|---|
| <p>1 Mains switch</p> <p>2 Light switch</p> <p>3 Button »Man« for manual operating mode, if switched on green LED is lit.</p> <p>4 Button to acknowledge reminder sound to measure body temperature every 15 minutes if heat level is greater than 5. After acknowledgement the yellow LED goes out.</p> <p>5 Green bargraph display for heat output 1 segment represents a heat change of 10 %; next to it on the left: button to reduce heat output; next to it on the right: button to increase heat output.</p> <p>6 Button »Auto« (automatic operating mode); green LED is lit when button is pressed = skin temperature control has been switched on.</p> <p>7 Red LED Sensor, is lit during skin temperature control if the skin temperature sensor has been disconnected or is faulty.</p> <p>8  Follow the Instructions for Use of the skin temperature control.</p> <p>9 Red LED ± 0.5 °C, flashes if the measured value for skin temperature deviates from set value by more than ± 0.5 °C.</p> | <p>10 Socket for skin temperature sensor</p> <p>11 Button for 10 minute suppression of intermittent sound, the yellow LED is lit when intermittent sound is muted.</p> <p>12 Button to simulate the temperature 36 ± 0.1 °C (reference).</p> <p>13 Display of set value of skin temperature next to it on the left: button to reduce; next to it on the right: button to increase.</p> <p>14 Display for measured value for skin temperature</p> <p>15 Timer display; next to it on the left: button to start; next to it on the right: button to stop (1x) / reset (2x).</p> <p>16 Yellow LED ; lights/flashes in step with the heat pulses.</p> <p>17 Red LED ; is lit during voltage failure.</p> <p>18 Red LED Inop, is lit for a malfunction.</p> |
|---|---|

Technical Data

Ambient conditions

For operation:	
Temperature	20 °C to 30 °C
Atmospheric pressure	900 hPa to 1100 hPa
Relative humidity	0 to 90 %, no condensation
For storage/transport:	
Temperature	-20 °C to 60 °C
Atmospheric pressure	900 hPa to 1100 hPa
Relative humidity	0 to 90 %, no condensation

Mattress heating, optional

Temperature measurement	
Measurement range	5 °C to 45 °C
Accuracy	±0.5 °C in 20 to 42 °C range ±2 °C in remainder of operating range
Specified range	30 °C to 38.5 °C

Radiant heater

Heat output, 80 cm away from radiant heater	
heat level 5	7 mW/cm ²
heat level 10	14 mW/cm ²
Lamp	Halogen 12 V / 35 W
Timer	0 to 99 minutes, 59 seconds; start, stop in seconds; reset function; acoustic signal at 1 minute, 5 minutes, 10 minutes
Clearance between top of heater and ceiling	>50 cm

Skin temperature measurement

Sensor	use only authentic Dräger sensor, see Order List, page 49.
Measurement range	33 °C to 38 °C
Accuracy	±0.1 °C
Accuracy of measurement system	±0.2 °C
Specified range	35 °C to 37 °C

Height adjustment, optional

Additional height range	295 mm
Operation	Maximum operating time of 1 min must be followed by 60 min cooling time.

Technical Data

Operating data

160 VA

Mains voltage

100/120/127/230/240 V (as ordered)
50/60 Hz

Power consumption

Mattress heating, optional

160 W

Radiant heater

680 W

Height adjustment, optional

560 W

Fuses

Mattress heating, optional

100 V to 127 V

T 1.6 A L 250 V; IEC 127-2/III (2 ea.)

230 V to 240 V

T 800 mA L 250 V; IEC 127-2/III (2 ea.)

Radiant heater

M 6.3 A L 250 V; IEC 127-2/III (2 ea.)

Height adjustment, optional

100 V to 127 V

T 3.15 A L 250 V; IEC 127-2/III (2 ea.)

230 V to 240 V

T 6.3 A L 250 V; IEC 127-2/III (2 ea.)

Protection class

Heating surface of mattress

I



Type BF

Skin temperature sensor, radiant heater



Type B

Standard

IEC 601-1 corresponding to DIN VDE 750 Part 1
62 D (Sec) 146 IEC 601-2-35 Part 2, for mattress heating
IEC 601-2-21, for radiant heater

Electromagnetic compatibility (EMC)

according to EN 60601-1-2

Dimensions

Length x width

1320 x 750 mm

Total height

Basic unit without height adjustment

1930 mm

Basic unit with height adjustment, small column

1790 to 2085 mm

Basic unit with height adjustment, large column

1855 to 2150 mm

Working height of the resting surface

without height adjustment

1025 mm

with height adjustment, small column

885 to 1180 mm

with height adjustment, large column

950 to 1245 mm

Resting surface

750 x 490 mm

Tilting of resting surface

adjustable in fine steps
maximum of 20° down, maximum of 15° up

Height of side panels 150 mm or
230 mm (when using the cover)

Height of inner panels 70 mm

Weight (with one swivel unit)

Basic unit without height adjustment
with mattress heating 135 kg
without mattress heating 121 kg

Basic unit with height adjustment
with mattress heating 116 kg
without mattress heating 102 kg

Design and Description

Mattress heating

The mattress heating consists of a gel mattress, an aluminum heating plate and an electronic control and monitoring unit.

The gel mattress consists of a gel with excellent heat-conducting properties, which remains solid even when the cot is tilted. The gel is surrounded by a soft film, which does not irritate the skin.

The mattress moulds itself to the body contours of the patient lying on it. A large contact surface results, which directs the heat to the patient and avoids pressure points (anti-decubitus effect). When cold, the gel mattress dissipates the patient's heat.

The gel stores heat well. When the power supply is disconnected (e. g. for transport within the clinic), the patient is kept warm for approximately 15 minutes if sufficiently insulated (blanket, cover).

The aluminum heating plate consists of a 6 millimeter thick aluminum plate and the surface heater attached below it. It distributes the heat evenly over the entire resting surface.

The control and monitoring unit is located under the heating plate. The membrane keypad with the operating buttons and displays faces the ergonomically best side. The temperature is set to a specified value. This value is only reached at the points at which the patient contacts the mattress.

Checking routines and warning devices provide monitoring.

Radiant heater

The radiant heater for infants consists of a heater and a control system.

The heating component has 4 infra-red ceramic radiant heaters and a low-voltage halogen lamp.

The ceramic radiant heaters are positioned to ensure that heat is evenly distributed over the entire bed.

The halogen lamp provides good lighting over the work area and – in contrast to an electric light bulb – good colour reproduction, so that diagnostically important colour nuances are more easily recognised.

The control system is fitted inside the housing at the side. The touch keyboard with display and entry buttons is on the side facing the working area.

Fixed heat output is set with manual control (manual operating mode).

The skin temperature is controlled at a set value by the skin temperature control system (auto operating mode). In both operating modes, control routines and alarm facilities provide the monitoring function.

The built-in timer, activated at the moment of birth, gives a reminder sound at the times which are relevant for the APGAR score (1 minute, 5 minutes, 10 minutes).

Order List

Name and Description	Order No.	Name and Description	Order No.
Babytherm 8000 OC Voltage level as ordered Variation as ordered:	FR 00 048	Bronchial aspirator	
– Set of side panels, height 230 mm or set of side panels, height 150 mm		Bronchial aspirator complete, ejector to 0.5 bar, with rail coupling	2M 85 045
– 2 inner panels or no inner panels		Bronchial aspirator complete, ejector to 0.9 bar, with rail coupling	2M 85 040
– Mattress heating with gel mattress or foam rubber mattress unheated		Bronchial aspirator complete, vacuum to 0.9 bar, with rail coupling	2M 85 041
– Trolley frame with electrical height adjustment or trolley frame with fixed column		Holder for hoses	2M 85 239
– Without swivel unit, with one swivel cabinet or with two swivel units (only trolley frame with electrical height adjustment)		Bronchial aspirator, ejector to 0.5 bar; with hardware for placement under resting area	2M 21 187
– Shortened base plate/trolley (Length 1050 mm) without instrument tray		Bronchial aspirator, ejector to 0.9 bar; with hardware for placement under resting area	2M 21 188
Orderable options		Bronchial aspirator, vacuum to 0.9 bar; with hardware for placement under resting area	2M 21 189
Set of side panels, height 230 mm	2M 21 034	Connecting hoses	
Set of side panels, height 150 mm	2M 21 032	O ₂ air connecting hose 1.5 m	M 29 283
Inner panels, height 70 mm	2M 20 936	O ₂ air connecting hose 3 m	M 29 243
Swivel unit	2M 20 638	O ₂ air connecting hose 5 m	M 29 263
Cabinet fastening	2M 20 868	Air connecting hose 5 m	M 29 259
		Vacuum connecting hose 1.5 m	M 29 287
		Vacuum connecting hose 3 m	M 29 247
		Vacuum connecting hose 5 m	M 29 2745
Attachable parts		Phototherapy	
Cover	2M 21 030	Photo-Therapy 4000	2M 21 000
Infusion bottle holder	2M 16 520	Stand for phototherapy unit	2M 21 190
Inner panel, left for drainage bag	2M 21 150		
Holder for breathing hoses	2M 21 191		
Swivel table	2M 21 186		
Compact rail	2M 85 337		
Cable holder, 4 ea.	G 13 171		
Second shelf (one shelf equipped)	2M 21 158		
Rail for shelf	2M 21 161		

Name and Description	Order No.	Name and Description	Order No.
Oxygen therapy with hood		For bronchial aspiration	
O2 hood	2M 19 250	Aspirator hose 1.5 m	M 25 780
O2 flowmeter, 0 to 16 L/min	2M 85 501	Secretion sight glass, 5 ea.	M 07 582
Nebulizer	M 19 995	Bacterial filter CH 102, 5 ea.	67 23 976
Corrugated hose, 1 m (5 ea.)	2M 17 478	Jar	M 20 091
Oxydig, O2 monitor	83 04 411	Jar cap with valve, plastic	2M 85 012
Oxydig monitor holder	2M 17 770		
Connecting hoses		O2 sensor capsule	68 50 645
O2 connecting hose	1.5 m M 29 271	Oxydig sensor housing	68 50 250
O2 connecting hose	3 m M 29 231		
O2 connecting hose	5 m M 29 251	For manual ventilation with bag	
O2 distributor for pipeline system	2M 18 810	Bag for manual ventilation	21 20 941
O2 distributor for O2 cylinder	2M 18 828	Connecting socket	M 06 258
O2 cylinder AG 2/200, G 3/4"	B 02 352	O2 reservoir	21 21 050
O2 cylinder AG 3/200, G 3/4"	B 02 533		
Consumable parts		Servicing documents on demand.	
Foam rubber mattress for unheated resting surface	2M 21 012		
Gel mattress for mattress heating	2M 20 827		
Repair set for gel mattress	2M 21 324		
Mattress cloth	2M 21 272		
Skin temperature sensor, uncalibrated, incl adhesive rings (pack of 250)	82 00 757		
Adhesive ring (pack of 250)	68 50 021		
Set skin temperatur sensor, pin-shaped, one way part, 10 ea.	2M 20 737		
Adapter cable for pin-shaped skin temperature sensor	2M 20 736		
Halogen lamp 12 V, 35 W	18 33 537		
Flexible hose seals	2M 20 434		

Index

- Adjusting the height**..... 5
Alarms..... 19, 26
Ambient conditions..... 43
- Babylog 2000, using** 33
Before the next use..... 35
Bronchial aspiration..... 6, 33
- Care**..... 35
Checking operational readiness..... 3, 15, 21
Checking lighting..... 22
Cleaning, disinfecting, sterilizing..... 35
Compact rail..... 7
Cot, preparing..... 10, 11
 tilting..... 11
- Design and description**..... 46, 47
Disposal of batteries..... 36
- Fault, cause, remedy**..... 37, 38
- Gel mattress**..... 15
- Halogen lamp**..... 28
Heat therapy..... 14
Hood..... 33
- Inner clinical transport**..... 12
Intended use..... 4
- Mains failure alarm**..... 17, 21
Maintenance intervals..... 36
Mattress heating..... 15-19
Mattress type..... 11
- Notes on setting**..... 29-31
NiCd battery, checking..... 21
- Order list**..... 48
Oxygen therapy..... 32
- Phototherapy**..... 34
Preparing 5-13
Preparing accessories..... 6-9, 10, 11
Prior to each use..... 13
Prior to initial use..... 13
- Radiant heater**..... 20-28
 setting heat output manually..... 22
- Safety precautions**..... 14, 15, 20, 32
Sensor, faulty..... 26
Sensor plug..... 24
Shelf..... 7
Skin temperature control
 operating..... 25
 using..... 23
Skin temperature sensor, connecting..... 24
Specified values, setting
 Mattress heating..... 18
 Radiant heater..... 26
Specified values, extending..... 18
Stabilisation time..... 27
Stability of the unit..... 9
Stand..... 7
Stripping down..... 35
- Technical data**..... 43
Timer..... 27
- Warming-up time**..... 15, 22
What is what..... 39-42
- X-raying**..... 34

These Instructions for Use apply only to
Babytherm 8000 OC (FR 00 048)
with Serial No.:

If no Serial No. has been filled in by
Dräger these Instructions for Use are
provided for general information only and
are not intended for use with any specific
machine or device.



Directive 93/42/EEC
concerning Medical Devices

Dräger Medizintechnik GmbH

Germany

🏠 Moislinger Allee 53 – 55
D-23542 Lübeck

☎ +49 451 8 82 - 0

📠 26 80 70

FAX +49 451 8 82-20 80

🌐 <http://www.draeger.com>