

# ZOLL Base PowerCharger<sup>4x4</sup>

## Operator's Manual

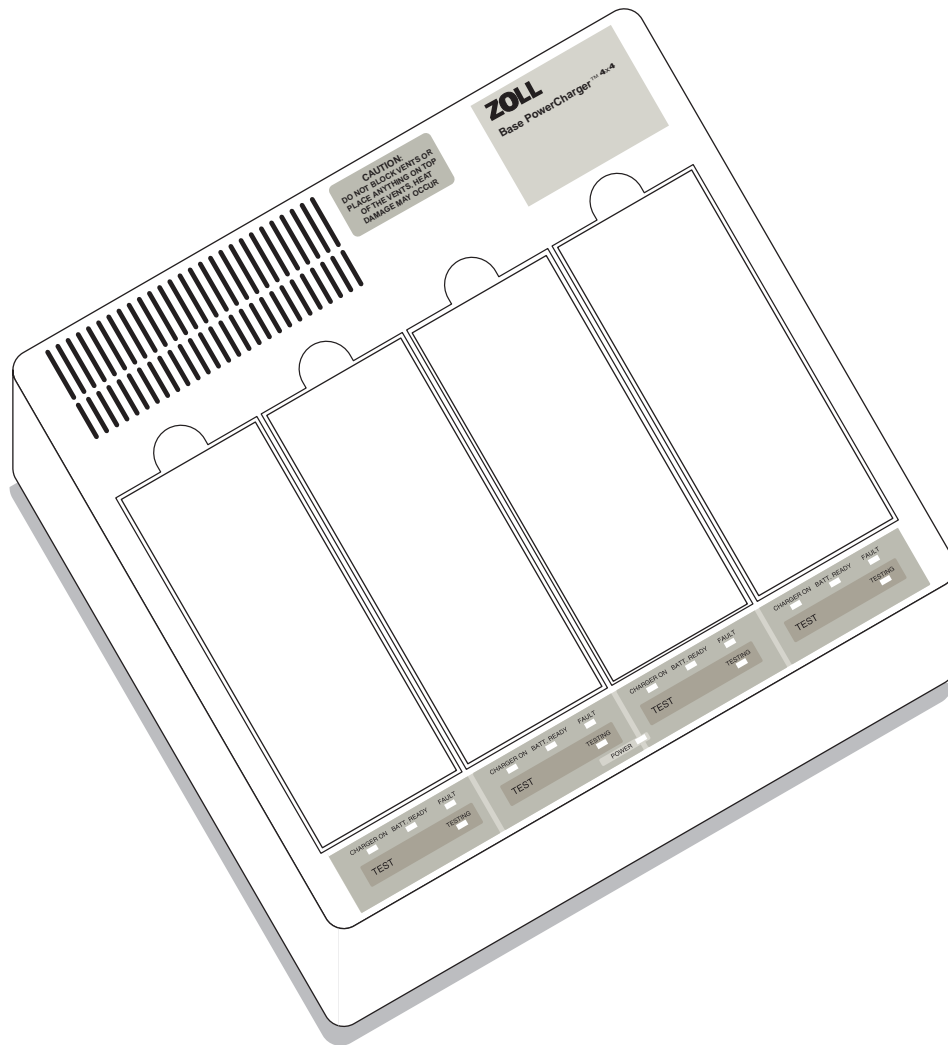

**ZOLL**

Part Number 9650-0054 Rev. G

The revision level for this document is shown on the front cover.

ZOLL, PowerCharger<sup>4x4</sup>, QuickCharge, and AutoTest are trademarks of ZOLL Medical Corporation.

© 2002 by ZOLL Medical Corporation. All rights reserved.

**Service Policy Warranty**

In North America: Consult your purchasing agreement for terms and conditions associated with your warranty.

Outside of North America, consult the ZOLL authorized representative.

In order to maintain this warranty, the instructions and procedures contained in this guide must be strictly followed.

For additional information, please call the ZOLL Technical Service Department 1-800-348-9011 in North America.

(International customers: 978-421-9655).

# Table of Contents

<b>Section 1</b>	<b>General Information</b> .....	<b>1</b>
	Product Description .....	1
	How to Use This Manual .....	2
	Section Descriptions .....	2
	Manual Updates.....	2
	Unpacking.....	2
	FDA Regulations .....	2
	Warranty (U.S. Only) .....	3
	Use of Non-Standard Accessories with ZOLL Equipment .....	3
	Warnings and Cautions .....	4
	Specifications.....	5
	Symbols Used on the Equipment.....	6
	Service .....	6
<b>Section 2</b>	<b>Operation (QuickCharge)</b> .....	<b>7</b>
	Operating Controls and Indicators .....	8
	Setup .....	8
	Battery Charging Procedure (QuickCharge).....	8
	Manual Battery Testing Procedure .....	9
	Battery Compartment Testing Procedure .....	10
	Fault Codes and Definitions.....	11
	Quick Reference Chart for ZOLL Base PowerCharger <sup>4x4</sup> with QuickCharge .....	12
<b>Section 3</b>	<b>Operation (AutoTest)</b> .....	<b>13</b>
	Operating Controls and Indicators .....	14
	Setup .....	14
	Battery Charging Procedure (AutoTest).....	14
	Manual Battery Testing Procedure .....	15
	Battery Compartment Testing Procedure .....	16
	Fault Codes and Definitions.....	17
	Quick Reference Chart for ZOLL Base PowerCharger <sup>4x4</sup> with AutoTest .....	18
<b>Section 4</b>	<b>Maintenance and Troubleshooting</b> .....	<b>19</b>
	Inspection .....	19
	Cleaning .....	19
	Operational Checks .....	19
	Changing the AC Line Setting of the ZOLL Base PowerCharger <sup>4x4</sup> .....	19
	Troubleshooting .....	20
<b>Section 5</b>	<b>Battery Management</b> .....	<b>21</b>
	ZOLL Battery Packs .....	21
	Battery Life Expectancy .....	21
	Low Battery Message .....	21
	Battery Disposal.....	21

(This page intentionally left blank.)

# Section 1

## General Information

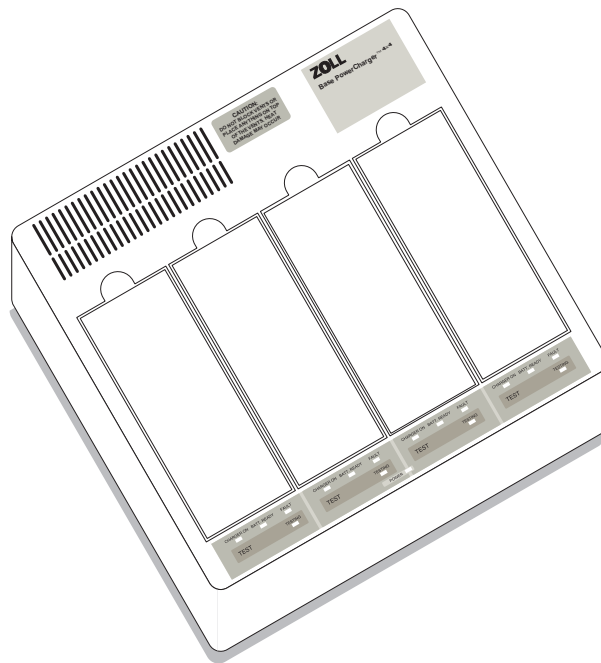

### Product Description

The ZOLL Base PowerCharger <sup>4x4</sup> (with QuickCharge or AutoTest) is a battery charger and testing system designed for management of PD 4410/Smart/Smart Ready Battery and all XL Battery packs used in ZOLL Medical Corporation resuscitation devices.

The ZOLL Base PowerCharger <sup>4x4</sup> (with QuickCharge or AutoTest) provides four battery charging/testing compartments. Up to four battery packs may be charged or tested in any combination at one time.

The ZOLL Base PowerCharger <sup>4x4</sup> can be configured in either **AutoTest** or **QuickCharge** mode. This configuration is performed by ZOLL Medical Corporation prior to device shipment. The ZOLL Base PowerCharger <sup>4x4</sup> is clearly labeled **AutoTest** or **QuickCharge** on the charger label directly beneath the product name. If the device is not labeled, the QuickCharge instructions should be followed for proper device operation. For questions concerning the charger's configuration, please consult a ZOLL technical service representative.

### AutoTest

The ZOLL Base PowerCharger <sup>4x4</sup> with AutoTest automatically tests battery capacity with each battery recharge. In addition, the ZOLL Base PowerCharger <sup>4x4</sup> with AutoTest illuminates the **Batt. Ready** indicator when the battery is fully charged and capable of powering an M Series equipped with Pace/Defibrillation and Pulse Oximetry (SpO<sub>2</sub>) for approximately 1.5 hours in Monitor mode. Fully charged batteries whose capacity is insufficient will cause the **FAULT** light to illuminate. With AutoTest, the full charging cycle is complete in eight (8) hours or less for the PD 4410/Smart/Smart Ready Battery, and fifteen (15) hours or less for all XL Batteries. The AutoTest feature virtually eliminates the need to periodically test battery capacity since this test is performed each time a battery is recharged.

### QuickCharge

The ZOLL Base PowerCharger <sup>4x4</sup> with QuickCharge illuminates the **Batt. Ready** indicator when the battery is fully charged. The full charging cycle is complete in four (4) hours or less for the PD 4410/Smart/Smart Ready Battery and eight (8) hours or less for all XL Batteries. The QuickCharge version provides **no** information regarding battery capacity

because it does **not** test the battery capacity with each recharge. The ZOLL Base PowerCharger 4x4 with QuickCharge relies on the user to manually initiate the battery test cycle at recommended intervals (see "Manual Battery Testing Procedure" on page 9) in order to confirm adequate battery capacity.

### How to Use This Manual

This manual provides information necessary for the use and care of the ZOLL Base PowerCharger 4x4, PD 4410/ Smart/Smart Ready Battery and all XL Battery packs. A thorough understanding of this information is required for proper charging and maintenance of ZOLL batteries. Reliable operation of ZOLL Medical Corporation resuscitation devices requires proper battery care.

### Section Descriptions

This manual is divided into five sections. The operator should read each section carefully.

#### Section 1 - General Information

Provides Cautions, Warnings and a general product overview of the ZOLL Base PowerCharger 4x4. Includes detailed product specifications, important ZOLL service information, and ZOLL's warranty statement.

#### Section 2 - Operation (QuickCharge)

Describes the function of all controls and indicator lights of the ZOLL Base PowerCharger 4x4 with QuickCharge. Discusses proper setup of the ZOLL Base PowerCharger 4x4 and provides charging and testing instructions.

#### Section 3 - Operation (AutoTest)

Describes the function of all controls and indicator lights of the ZOLL Base PowerCharger 4x4 with AutoTest. Discusses proper setup of the ZOLL Base PowerCharger 4x4 and provides charging and testing instructions.

#### Section 4 - Maintenance and Troubleshooting

This section describes several routine checks to assure proper unit operation. It includes cleaning and maintenance instructions and troubleshooting guides intended for use by non-technical personnel.

#### Section 5 - Battery Management

Provides information for determining your particular battery requirements and program implementation steps to set up a comprehensive, effective and safe battery management program.

### Manual Updates

If you purchased your product more than three years ago, contact ZOLL to determine whether updates to your documentation are available. For information relating to recent manual updates, contact ZOLL Medical Corporation's Technical Service Department at 1-978-421-9655.

### Unpacking

Carefully inspect each container for damage. If the shipping container or cushion material is damaged, it should be kept until the contents have been checked for mechanical and electrical integrity. If the contents are incomplete, if there is mechanical damage, or if the instrument does not pass its electrical self-test, U.S.A. customers should call ZOLL Technical Service (1-800-348-9011). International customers should contact the nearest ZOLL authorized representative. If the shipping container is damaged, also notify the carrier.

### FDA Regulations

#### Notification of Adverse Events

As a health care provider, you may have responsibilities under the Safe Medical Devices Act (SMDA), for reporting to ZOLL and possibly to the FDA the occurrence of certain events. These events, described in 21 CFR Part 803, include device-related death and serious injury or illness.

In any event, as part of our Quality Assurance Program, ZOLL Medical Corporation should be notified of any device failures or malfunctions. This information is required to assure that ZOLL provides only the highest quality products.

## Warranty (U.S. Only)

(a) ZOLL Medical Corporation warrants to the original equipment purchaser that beginning on the date of installation, or thirty (30) days after the date of shipment from ZOLL Medical Corporation's facility, whichever first occurs, the equipment (other than accessories and electrodes) will be free from defects in material and workmanship under normal use and service for the period of one (1) year. During such period ZOLL Medical Corporation will, at no charge to the customer, either repair or replace (at ZOLL Medical Corporation's sole option) any part of the equipment found by ZOLL Medical Corporation to be defective in material or workmanship. If ZOLL Medical Corporation's inspection detects no defects in material or workmanship, ZOLL Medical Corporation's regular service charges shall apply. (b) ZOLL Medical Corporation shall not be responsible for any equipment defect, the failure of the equipment to perform any function, or any other nonconformance of the equipment, caused by or attributable to: (i) any modification of the equipment by the customer, unless such modification is made with the prior written approval of ZOLL Medical Corporation; (ii) the use of the equipment with any associated or complementary equipment, (iii) installation or wiring of the equipment other than in accordance with ZOLL Medical Corporation's instructions. (c) This warranty does not cover items subject to normal wear and burnout during use, including but not limited to lamps, fuses, batteries, patient cables and accessories. (d) The foregoing warranty constitutes the exclusive remedy of the customer and the exclusive liability of ZOLL Medical Corporation for any breach of any warranty related to the equipment supplied hereunder. (e) Limitation of Liability: ZOLL shall not in any event be liable to Purchaser, nor shall Purchaser recover, for special, incidental or consequential damages resulting from any breach of warranty, failure of essential purpose, or under any other legal theory including but not limited to lost profits, lost savings, downtime, goodwill, damage to or replacement of equipment and property, even if ZOLL has been advised of the possibility of such damages.

THE WARRANTY SET FORTH HEREIN IS EXCLUSIVE AND ZOLL MEDICAL CORPORATION EXPRESSLY DISCLAIMS ALL OTHER WARRANTIES WHETHER WRITTEN, ORAL, IMPLIED, OR STATUTORY, INCLUDING BUT NOT LIMITED TO ANY WARRANTIES OF MERCHANTABILITY OR FITNESS FOR A PARTICULAR PURPOSE.

For additional information, please call ZOLL Medical Corporation at 1-800-348-9011 (in Massachusetts: 1-978-421-9655). International customers should call the

nearest authorized ZOLL Medical Corporation service center.

## Use of Non-Standard Accessories with ZOLL Equipment

Safety and effectiveness data submitted to the Food and Drug Administration (FDA) by ZOLL Medical Corporation to obtain approval to market is based upon the use of ZOLL accessories such as disposable electrodes, patient cables and batteries.

## Warnings and Cautions

### Warnings

#### General

- The ZOLL Base PowerCharger 4x4 is protected against interference from radio frequency emissions typical of two-way radios used in emergency service/public safety activities. Users of the ZOLL Base PowerCharger 4x4 should assess the devices' performance in their environment of use for the possibility of radio frequency interference from high-power sources.
- Use only the AC power line cord supplied with the device. Failure to use the proper line cord could result in excess leakage currents and reduced safety.
- Do not disassemble the ZOLL Base PowerCharger 4x4. A shock hazard exists. Refer all problems to ZOLL Technical Service.
- Follow all recommended maintenance instructions. If a problem occurs, obtain service immediately. Do not use the ZOLL Base PowerCharger 4x4 until the unit has been inspected by the appropriate personnel.
- Do not place anything on top of or beneath the ZOLL Base PowerCharger 4x4, such as blankets or cloths. Doing so may block the vents on the unit, preventing proper dissipation of heat during operation.
- Do not sterilize the ZOLL Base PowerCharger 4x4.
- Do not use alcohol or ketones (MEK, acetone, etc.) on the ZOLL Base PowerCharger 4x4.
- Always wait until the ZOLL Base PowerCharger 4x4 has completed its charge cycle before removing batteries.
- Repeated use of partially charged batteries will reduce their capacity and operating life.
- Do not use a battery unless the **BATT. READY** indicator is lit and the **FAULT** light is off. Failure to do so may result in the use of a fully depleted battery.
- Only charge XL Battery packs in a ZOLL Base PowerCharger 4x4 marked "XL Battery Ready". Failure to do so will reduce battery capacity and operating life.

- Do not install batteries into Monitor/Defibrillators when storage may exceed 90 days. Battery damage may occur.

#### Operator Safety

- Do not operate the ZOLL Base PowerCharger 4x4 in the presence of flammable agents (such as gasoline), oxygen-rich atmospheres, nitrous oxide, or flammable anesthetics. Using the device near the site of a gasoline spill may cause an explosion.
- Do not immerse or set the ZOLL Base PowerCharger 4x4 in fluid. Using the device near or within puddles of water may present a shock hazard to the operator, patient, and nearby personnel.

#### Patient Safety

- Do not mount the device directly above the patient. Locate the ZOLL Base PowerCharger 4x4 and ZOLL resuscitation devices where they cannot harm the patient if they fall.

#### Caution

- Federal (U.S.A.) law restricts this device to sale by or on the order of a physician.
- When a fully charged battery is placed into the ZOLL Base PowerCharger 4x4 with the AutoTest, the AutoTest will **NOT** activate and the **BATT. READY** indicator will illuminate within a few minutes after inserting the battery into the charger. Therefore, it is possible to have a shorter battery run time than expected from the AutoTest.



**Specifications**

**ZOLL Base PowerCharger 4x4**

**General**

<b>Size</b>	4.2 " H x 13.2 " W x 12.2 " L inches
<b>Weight</b>	4.1 kg (9.0 lbs) without batteries.
<b>Equipment Type</b>	IEC Type B
<b>Power Requirements</b>	100-120 VAC, 50/60 Hz input. 220-240 VAC, 50/60 Hz input.
<b>Power Consumption</b>	100 watts maximum.
<b>Design Standards</b>	Designed to meet or exceed UL 544, EN 60601, and CSA 22.2 standards for medical equipment safety.

**Recharge Time**

<b>QuickCharge</b>	Total recharge of fully depleted battery: <ul style="list-style-type: none"> <li>• 4 hours or less for the PD 4410/Smart/Smart Ready Battery.</li> <li>• 8 hours or less for all XL Batteries.</li> </ul>
<b>AutoTest</b>	AutoTest and total recharge of fully depleted battery: <ul style="list-style-type: none"> <li>• 8 hours or less for the PD 4410/Smart/Smart Ready Battery</li> <li>• 15 hours or less for all XL Batteries</li> </ul>

<b>Temperature</b>	5 °C to 40 °C (operating) 15°C to 35°C (optimal battery charging) -40°C to 70°C (storage and transportation)
<b>Humidity</b>	5% to 95% (relative humidity - non condensing).
<b>External Fuses</b>	2 Type T, 2A/250V Time Delay fuses located above AC mains input.

**Indicator Lights**

<b>POWER</b>	Illuminates when ZOLL Base PowerCharger 4x4 is plugged into live AC mains.
<b>CHARGER ON</b>	Indicates battery is being charged. Separate indicator light for each battery compartment.
<b>BATT.READY</b>	Illuminates when the charge cycle is complete. Separate indicator light for each battery compartment.
<b>FAULT</b>	Illuminates when battery capacity test or battery compartment test fails. Separate indicator light for each battery compartment.

**TESTING**

Illuminates when either a battery test or a battery compartment test is in progress. Separate indicator light for each battery compartment.

*ZOLL Base PowerCharger 4x4 with AutoTest only:*

Illuminates with the **CHARGER ON** light during AutoTest and recharge of the battery

**Controls**

**TEST Button**

Illuminates TESTING indicator light and initiates battery test cycle or battery compartment test.

Automatically charges, discharges and recharges the battery.

Separate indicator light for each battery compartment.

**ZOLL Batteries**

**Type**

Rechargeable, sealed lead acid:  
ZOLL Battery Pack PD4410  
ZOLL Smart Ready Battery  
ZOLL Smart Battery  
ZOLL XL Smart Ready Battery  
ZOLL XL Smart Battery

**Weight**

PD 4410/Smart/Smart Ready Battery: 1 kg (2.2 lbs)  
XL Battery: 1.68 kg (3.7 lbs)

**Size**

PD 4410/Smart/Smart Ready Battery:  
4 cm H x 7 cm W x 18.9 cm L  
(1.6 in. x 2.8 in. x 7.4 in.)  
XL Battery:  
9.4 cm H x 7 cm W x 20 cm L  
(3.7 in. x 2.8 in. x 7.9 in.)

**Capacity**

PD 4410/Smart/Smart Battery:  
2.5 Amp Hour rating for new batteries  
XL Battery:  
4.5 Amp Hour rating for new batteries

**Nominal Battery Voltage**

2.0 V/cell; 5 cells.

**Temperature**

0 °C to 50 °C (operating)  
15°C to 35°C (optimal battery charging)  
-40°C to 70°C (storage and transportation)

**Humidity**











5% to 95% (relative humidity - non condensing).

**Capacity Test**

At a minimum, test batteries every three (3) months. Refer to ZOLL's Battery Management Program brochure.

## Symbols Used on the Equipment

Any or all of the following symbols may be used in this manual or on this equipment:

	Type B patient connection
	Type BF patient connection
	Type CF patient connection
	Defibrillation protected Type BF patient connection
	Defibrillation protected Type CF patient connection
	<b>Attention</b> Refer to manual for more information
	Fusible Link
	Protective (earth) ground terminal
	<b>DANGER</b> High Voltage present
	Alternating current
	<b>Conformité Européenne</b> Complies with the medical device directive 93/42/EEC

## Service

The device does not require periodic recalibration or adjustment. Appropriately trained and qualified personnel should, however, perform periodic tests of the device to ensure proper operation. See the "Operation" sections for both QuickCharge and AutoTest for more information.

### U.S.A. Customers

Should the ZOLL Base PowerCharger 4x4 require service, contact ZOLL Medical Corporation at 1-800-348-9011 (in Massachusetts: 1-978-421-9655).

Please have the following information available to expedite service:

- The unit's serial number
- A description of the problem
- Department where equipment is being used
- A purchase order to allow tracking of loan equipment

You will be given a Return Claim Number under which to return the ZOLL Base PowerCharger 4x4. Send the unit in its original packaging to:

**ZOLL** Medical Corporation  
269 Mill Road  
Chelmsford, MA 01824-4105

**Attn:** Technical Service Department

Loaner instruments are available for use while repairs are being completed by ZOLL's Technical Service Department.

### International Customers

Should the ZOLL Base PowerCharger 4x4 require service, return it, in its original container, to the nearest authorized ZOLL Medical Corporation service center.

# Section 2

## Operation (QuickCharge)

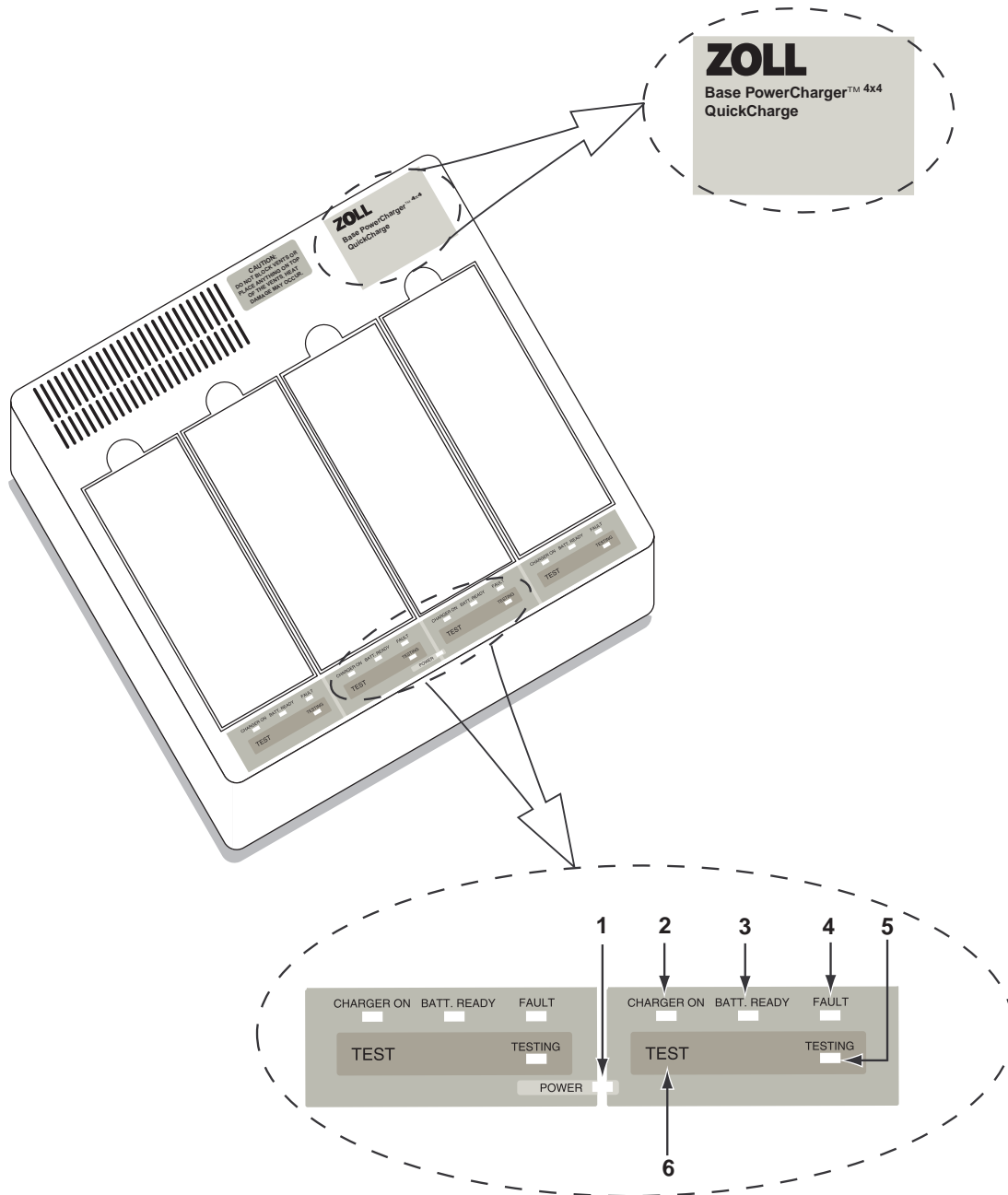

Refer to the Operating Controls and Indicators section on the next page for a description of each number.

**Note:** In this section, all references to ZOLL Base PowerCharger 4x4 refer to QuickCharge unless otherwise specified.

If your device does not indicate QuickCharge or AutoTest on the label (in the upper right corner), refer to the QuickCharge section of this manual for proper operating instructions.

### Operating Controls and Indicators

The ZOLL Base PowerCharger 4x4 with QuickCharge illuminates the **Batt. Ready** indicator when the battery is fully charged. The full charging cycle is complete in four (4) hours or less for the PD 4410/Smart/Smart Ready Battery and eight (8) hours or less for all XL Batteries. The QuickCharge device provides no information regarding battery capacity because it does **not** test the battery capacity with each recharge. The ZOLL Base PowerCharger 4x4 with QuickCharge relies on the user to manually initiate the battery test cycle at recommended intervals (see "Manual Battery Testing Procedure" on page 9) in order to confirm adequate battery capacity.

#### 1. POWER

Illuminates when the ZOLL Base PowerCharger 4x4 is connected to live AC mains and the unit is ready for charging and/or testing.

#### 2. CHARGER ON

Illuminates when a battery is properly installed in the corresponding charging/testing compartment and the charge cycle is in progress.

There are four **CHARGER ON** indicator lights. Each one corresponds to the battery charging/testing compartment directly above it.

#### 3. BATT. READY (QuickCharge)

Illuminates at the end of a charge cycle. Indicates that the battery has been charged to 100% of its present capacity and is ready for use. The **BATT. READY** light does **NOT** give any indication as to the available run time left in the battery.

Illuminates at the end of a battery test or battery compartment test and remains lit as long as battery remains in compartment. Indicates the battery compartment or battery has passed the capacity test and is operating properly.

There are four **BATT. READY** indicator lights. Each one corresponds to the battery charging/testing compartment directly above.

#### 4. FAULT

Illuminates, with the **TESTING** light, when a battery capacity test fails. Also, illuminates when a battery compartment or any other failure occurs.

There are four **FAULT** indicator lights. Each one corresponds to the battery charging/testing compartment directly above.

#### 5. TESTING

Illuminates when either a battery capacity test cycle is in progress or a battery compartment test is completed.

Illuminates with the **BATT. READY** light indicating a usable fully charged battery, capable of powering an M Series equipped with Pace/Defibrillation and Pulse Oximetry (SpO<sub>2</sub>) for approximately 1.5 hours in Monitor mode.

Illuminates with the **FAULT** light to indicate that a battery has failed the capacity test.

There are four **TESTING** indicator lights. Each one corresponds to the battery charging/testing compartment directly above.

#### 6. TEST button

Initiates a battery test cycle or battery compartment test. The battery capacity test cycle automatically charges, discharges and recharges the battery.

If a battery is installed in the battery compartment and the corresponding **TEST** button is pressed, a battery capacity test is performed. If the battery compartment is empty and the corresponding **TEST** button is pressed, a compartment test is performed and an audible tone will sound, indicating that the test has passed.

There are four **TEST** buttons. Each one corresponds to the battery charging/testing compartment directly above.

### Setup

Place the ZOLL Base PowerCharger 4x4 on a stable secure surface. There must be at least four (4) inches of clear space around the unit to allow for proper heat dissipation during charging or testing batteries. Do not place anything on top of or beneath the unit, such as blankets or cloths. Doing so may block the vents on the unit, preventing proper dissipation of heat during operation.

Turn the unit on by plugging the line cord into the power module at the rear of the unit and then into live AC mains.

### Battery Charging Procedure (QuickCharge)

The ZOLL PD 4410/Smart/Smart Ready Battery may be charged in any of the four battery compartments. XL Batteries should only be charged in a ZOLL Base PowerCharger 4x4 labeled "XL Battery Ready". Each battery charge compartment operates independently of the others. Four batteries may be charged simultaneously. Installation or removal of adjacent batteries will not affect the ongoing charging of batteries in other compartments. Correct placement of the battery into any compartment will automatically initiate the charging cycle.

To turn the ZOLL Base PowerCharger 4x4 on, plug the power cord into live AC mains. All indicator lights will illuminate for approximately five (5) seconds and then go off. An audible tone will sound indicating self test passed and the **POWER** light will remain lit.

To charge a battery:

1. Check to see that the unit is connected to live AC mains. The **POWER** light should be lit.
2. Insert a battery into any compartment. Make sure the battery is fully seated (a click can be heard).

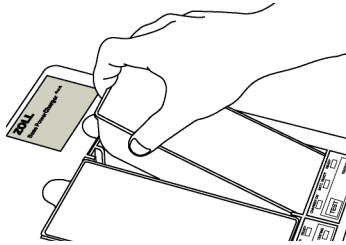

3. The **CHARGER ON** indicator illuminates and remains on during the charging cycle.

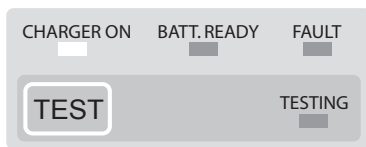

4. In four (4) hours or less for the PD4410/Smart/Smart Ready Battery and eight (8) hours or less for all XL Batteries, the **CHARGER ON** light will go off and the **BATT. READY** light will illuminate indicating the battery has been charged to 100% of its present capacity and is ready for use.

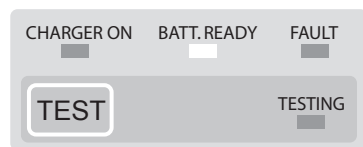

If the battery or battery compartment is not capable of charging, the **FAULT** light will illuminate and the **CHARGER ON** light may stay on.



To identify the defect, press and hold the **TEST** button while the battery is still in the compartment.

Illumination of certain indicator lights together represent a specific defect; see “Fault Codes and Definitions” on page 11 and take corrective action.

Before disposing of the battery, test the battery compartment for defective operation (see “Battery Compartment Testing Procedure” on page 10) and perform a battery test.

**Note:** Interrupting a charge cycle in progress by removing the battery will cause an audible warning of five (5) consecutive beeps to indicate that the battery is not fully charged and should not be used. In addition, all four indicator lights will illuminate for four (4) seconds and then go off.

Repeated use of partially charged batteries will reduce battery capacity and operating life.

5. To remove the battery, insert a finger into the recess at the top of the battery compartment, press against the battery to disengage the battery locking clip and lift the battery out. A compartment test is performed illuminating all indicator lights, briefly followed by the **BATT. READY** and **TESTING** indicator lights illuminating for two (2) seconds and then all indicator lights going off, except the **POWER** indicator light.

### Manual Battery Testing Procedure

ZOLL batteries are sealed lead-acid batteries. It is recommended that all batteries be tested for capacity at least every 90 days and that the test results and date be written on the battery label.

All four battery compartments can test batteries. It is not necessary to insert a fully charged battery for testing; the ZOLL Base PowerCharger 4x4 will automatically charge the battery first, test it, and then recharge the battery to full capacity. Testing a battery in one compartment will not affect any other charge or testing cycles in progress.

To test a battery:

1. Check to see that the ZOLL Base PowerCharger 4x4 is connected to live AC mains. The **POWER** indicator light should be lit.
2. Insert a battery into any compartment. Make sure the battery is fully seated (a click can be heard).

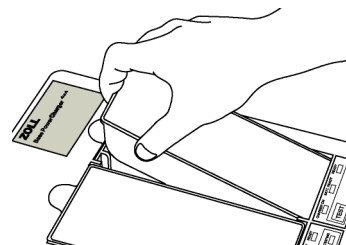

3. Press the **TEST** button for the appropriate compartment. The **TESTING** indicator light will

illuminate for the duration of the test cycle.

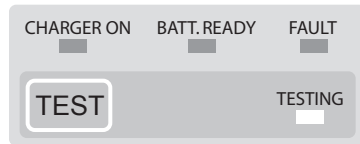

4. If the battery passes the test, the **BATT. READY** light will illuminate while the **TESTING** light remains lit. The battery is now recharged, ready for use, and capable of powering an M Series equipped with Pace/Defibrillation and Pulse Oximetry (SpO<sub>2</sub>) for approximately 1.5 hours in Monitor mode.
5. If a battery fails the test, the **FAULT** light will illuminate while the **TESTING** light remains lit. To identify the defect, press and hold the **TEST** button while the battery is still in the compartment. Illumination of certain indicator lights together represent a specific defect; see "Fault Codes and Definitions" on page 11 and take corrective action. Repeat test. Before disposing of the battery, test the battery compartment for possible defective operation (see "Battery Compartment Testing Procedure" on page 10).
6. Record the date and results of the test on the battery label.

**Note:** Interrupting a charge cycle in progress by removing the battery will cause an audible warning of five (5) consecutive beeps to indicate that the battery is not fully charged and should not be used. All four indicator lights will illuminate for four (4) seconds and then go off.

## Battery Compartment Testing Procedure

The ZOLL Base PowerCharger 4x4 has four battery compartments that are able to test and charge batteries simultaneously and independently of each other. In addition, the ZOLL Base PowerCharger 4x4 can test each battery compartment for defective operation through the simple press of a button.

To test a battery compartment:

1. Check to see that the unit is connected to live AC mains. The **POWER** light should be lit.
2. Remove the battery from the compartment to be tested.
3. Press the **TEST** button under the battery compartment.
4. All four indicator lights will illuminate for approximately 4-5 seconds.
5. If the **TESTING** light and **BATT. READY** light remain lit for three (3) seconds while the other lights go off, the compartment is fully operational and has no defects.
6. If the **FAULT** light is lit, the compartment is defective in some way.

To identify the defect, press and hold the **TEST** button. Illumination of certain indicator lights together represent a specific defect. See "Fault Codes and Definitions" on page 11 to identify the fault and take corrective action.

**Note:** Battery compartments operate independently of each other and one faulty compartment may not affect any others. However, there are common failures that can affect all compartments.

## Fault Codes and Definitions

When the **FAULT** indicator light illuminates, press and hold the **TEST** button. The illumination of the following indicator lights together represent a specific defect, identified under the Fault Code column.

CHARGER ON	BATT. READY	FAULT	TESTING	Fault Code
ON	ON	OFF	ON	Temperature
OFF	OFF	ON	OFF	Low Constant Current
ON	OFF	ON	OFF	High Constant Current
OFF	ON	OFF	ON	VCC Voltage
OFF	ON	ON	OFF	Low Power Supply Voltage
ON	OFF	ON	ON	Low Battery Voltage
OFF	ON	ON	ON	High Battery Voltage
ON	ON	ON	ON	Overcharge
OFF	OFF	ON	ON	Battery Capacity
ON	ON	ON	OFF	Discharge Time
ON	OFF	OFF	OFF	Constant Current Voltage
OFF	ON	OFF	OFF	Constant Voltage
ON	ON	OFF	OFF	Discharge
OFF	OFF	OFF	ON	Charger
ON	OFF	OFF	ON	Shutdown

### Definition of Fault Codes

<b>Temperature:</b>	Internal charger temperature deviated from the specified range.
<b>Low Constant Current:</b>	Amount of current during a charge was below the specified range.
<b>High Constant Current:</b>	Amount of current during a charge was above the specified range.
<b>VCC Voltage:</b>	Internal five (5) volt supply deviated from the specified range.
<b>Low Power Supply Voltage:</b>	Charging voltage was measured to be below the specified range.
<b>Low Battery Voltage:</b>	Battery voltage measured was below the specified range.
<b>High Battery Voltage:</b>	Battery voltage measured was above the specified range.
<b>Overcharge:</b>	Total delivered charge exceeded the specified range.
<b>Battery Capacity:</b>	Battery's capacity was measured to be below the specified range.
<b>Discharge Time:</b>	Unit is unable to perform the discharge test.
<b>Constant Current Voltage:</b>	Constant current compliance voltage is below the specified range.
<b>Constant Voltage:</b>	Constant voltage deviated from the specified range.
<b>Discharge:</b>	Test discharge has been ineffective.
<b>Charger:</b>	Safety shutdown (#1) is not operating properly (charge enable).
<b>Shutdown:</b>	Safety shutdown (#2) is not operating properly (shutdown).

**Quick Reference Chart for ZOLL Base PowerCharger 4x4 with QuickCharge**

The following chart describes the operation of the ZOLL Base PowerCharger 4x4 with QuickCharge. Illumination of specific indicator lights together represent a specific mode of operation, as noted in the **Description** column.

<b>LED OPERATION (QuickCharge)</b>					
	<b>CHARGER ON</b>	<b>BATT. READY</b>	<b>FAULT</b>	<b>TESTING</b>	<b>Description</b>
<b>QuickCharge with Battery in Compartment</b>	<b>ON</b>				Charging is in progress.
		<b>ON</b>			Charging is complete.
			<b>ON</b>		Charging is complete and the battery is NOT usable.
<b>Manual Test with Battery in Compartment and "TEST" button pushed</b>				<b>ON</b>	Manual Test is in progress.
		<b>ON</b>		<b>ON</b>	Manual Test is complete and the battery is in good condition.
			<b>ON</b>	<b>ON</b>	Manual Test is complete and the battery is NOT usable.

**Note:** If a battery is removed when the **FAULT** light is illuminated, the ZOLL Base PowerCharger 4x4 will beep to indicate the battery has been removed and should NOT be used.

The **POWER** light should be on as long as the unit is plugged into a live AC source.



# Section 3

## Operation (AutoTest)

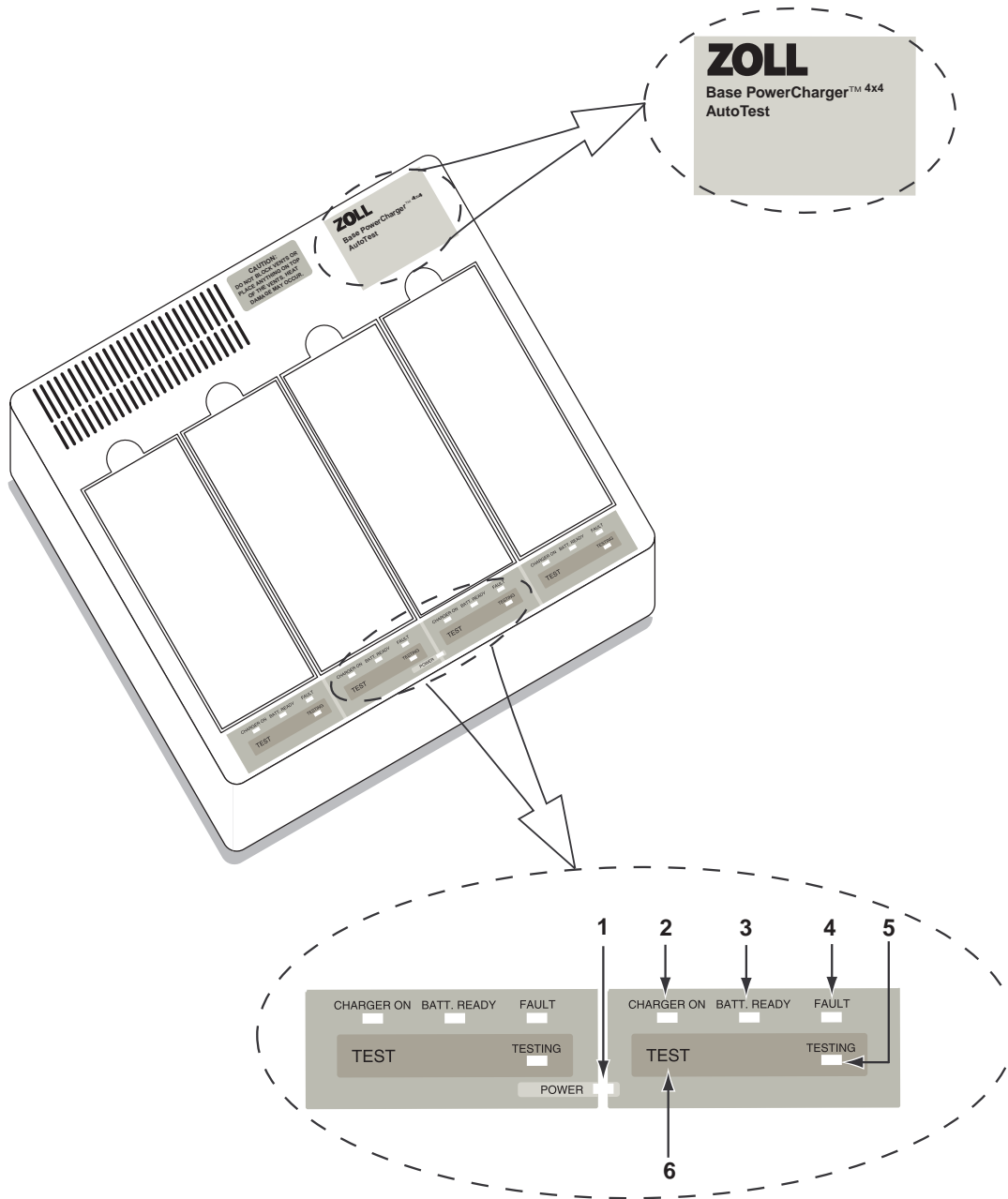

Refer to the Operating Controls and Indicators section on the next page for a description of each number.

**Note:** In this section, all references to ZOLL Base PowerCharger 4x4 refer to AutoTest unless otherwise specified.

If your device does not indicate QuickCharge or AutoTest on the label (in the upper right corner), refer to the QuickCharge section of this manual for proper operating instructions.

## Operating Controls and Indicators

The ZOLL Base PowerCharger 4x4 with AutoTest automatically tests battery capacity with each battery recharge.

The **BATT. READY** indicator light illuminates when the battery is fully charged and capable of powering an M Series equipped with Pace/Defibrillation and Pulse Oximetry (SpO<sub>2</sub>) for approximately 1.5 hours in Monitor mode. Fully charged batteries whose capacity is insufficient will cause a **FAULT** light to illuminate.

With AutoTest, the full charging cycle is complete in eight (8) hours or less for the PD 4410/Smart/Smart Ready Battery and fifteen (15) hours or less for all XL Batteries.

### 1. POWER

Illuminates when the ZOLL Base PowerCharger 4x4 is connected to live AC mains and the unit is ready for charging and/or testing.

### 2. CHARGER ON

Illuminates when a battery is properly installed in the corresponding charging/testing compartment and the charge cycle is in progress.

Illuminates with the **TESTING** light during AutoTest and recharge of the battery.

There are four **CHARGER ON** indicator lights. Each one corresponds to the battery charging/testing compartment directly above it.

### 3. BATT. READY (AutoTest)

Illuminates at the end of a test/charge cycle. Indicates that the battery has been charged to 100% of its present capacity and is ready for use.

Illuminates at the end of a battery test or battery compartment test and remains lit as long as the battery remains in the compartment. Indicates that the battery has passed the capacity test and has sufficient capacity to power an M Series equipped with Pace/Defibrillation and Pulse Oximetry (SpO<sub>2</sub>) for approximately 1.5 hours in Monitor mode, or that the battery compartment is operating properly.

There are four **BATT. READY** indicator lights. Each one corresponds to the battery charging/testing compartment directly above.

### 4. FAULT

Illuminates with the **TESTING** light when a battery fails the capacity test. Also, illuminates when a battery compartment or any other failure occurs.

There are four **FAULT** indicator lights. Each one corresponds to the battery charging/testing compartment directly above.

### 5. TESTING

Illuminates when either a battery capacity test cycle is in progress or a battery compartment test is completed.

Illuminates with the **BATT. READY** light indicating a fully charged battery, capable of powering an M Series equipped with Pace/Defibrillation and Pulse Oximetry (SpO<sub>2</sub>) for approximately 1.5 hours in Monitor mode.

Illuminates with the **CHARGER ON** light during AutoTest and recharge of the battery.

Illuminates with the **FAULT** light to indicate a battery that has failed the capacity test.

There are four **TESTING** indicator lights. Each one corresponds to the battery charging/testing compartment directly above.

### 6. TEST button

Initiates battery test cycle or battery compartment test. The battery capacity test cycle automatically charges, discharges and recharges the battery.

If a battery is installed in the battery compartment and the corresponding **TEST** button is pressed, a battery capacity test is performed. If the battery compartment is empty and the corresponding **TEST** button is pressed, a compartment test is performed and an audible tone will sound, indicating that the test has passed.

There are four **TEST** buttons. Each one corresponds to the battery charging/testing compartment directly above.

## Setup

Place the ZOLL Base PowerCharger 4x4 on a stable secure surface. There must be at least four (4) inches of clear space around the unit to allow for proper heat dissipation during battery charging or testing. Do not place anything on top of or beneath the unit, such as blankets or cloths. Doing so may block the vents on the unit, preventing proper dissipation of heat during operation.

Turn the unit on by plugging the line cord into the power module at the rear of the unit and then into live AC mains.

## Battery Charging Procedure (AutoTest)

The ZOLL PD 4410/Smart/Smart Ready Battery may be charged in any of the four battery compartments.

XL Batteries should only be charged in a ZOLL Base PowerCharger 4x4 labeled "XL Battery Ready". Each battery charge compartment operates independently of

the others. Four batteries may be charged simultaneously. Installation or removal of adjacent batteries will not affect the ongoing charging of batteries in other compartments. Correct placement of the battery into any compartment will automatically initiate the charging cycle.

To turn the ZOLL Base PowerCharger <sup>4x4</sup> on, plug the power cord into live AC mains. All indicator lights will illuminate for approximately five (5) seconds and then go off. An audible tone will sound indicating self-test passed and the **POWER** light will remain lit.

To charge a battery:

1. Check to see that the unit is connected to live AC mains. The **POWER** light should be lit.
2. Insert battery into any compartment. Make sure the battery is fully seated (a click can be heard).

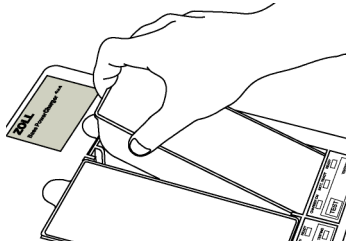

3. The **CHARGER ON** and **TESTING** indicator lights illuminate and remain on during the charging cycle.

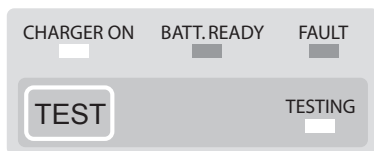

4. In eight (8) hours or less for the PD4410/Smart/Smart Ready Battery and fifteen (15) hours or less for all XL Batteries, the **CHARGER ON** light will go off and the **BATT. READY** light will illuminate indicating that the battery has passed the capacity test, is fully charged and is ready for use. The capacity test indicates that the battery has adequate capacity to power an M Series equipped with Pace/Defibrillation and Pulse Oximetry (SpO<sub>2</sub>) for approximately 1.5 hours in Monitor mode.

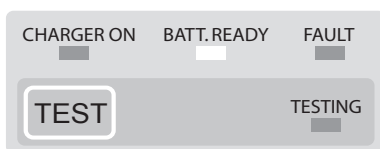

If the battery or battery compartment is not capable of charging, the **FAULT** light will illuminate and the **CHARGER ON** light may stay on.



To identify the defect, press and hold the **TEST** button while the battery is still in the compartment. Illumination of certain indicator lights together represent a specific defect; see "Fault Codes and Definitions" on page 17 and take corrective action. Before disposing of the battery, test the battery compartment for defective operation (see "Battery Compartment Testing Procedure" on page 16) and perform a battery test.

**Note:** Interrupting a charge cycle in progress by removing the battery will cause an audible warning of five (5) consecutive beeps to indicate that the battery is not fully charged and should not be used. All four indicator lights will illuminate for four (4) seconds and then go off.

Repeated use of partially charged batteries will reduce battery capacity and operating life.

5. To remove the battery, insert a finger into the recess at the top of the battery compartment, press against the battery to disengage the battery locking clip and lift the battery out. A compartment test is performed illuminating all indicator light, briefly followed by the **BATT. READY** and **TESTING** indicator lights illuminating for two (2) seconds and then all indicator lights going off, except the **POWER** indicator light.

### Manual Battery Testing Procedure

Although this test is available, the AutoTest feature eliminates the need to manually test batteries since battery capacity is automatically tested with each battery recharge.

All four battery compartments can test batteries. It is not necessary to insert a fully charged battery for testing; the ZOLL Base PowerCharger <sup>4x4</sup> will automatically charge the battery first, test it, and then recharge the battery to full capacity. Testing a battery in one compartment will not affect any other charge or testing cycles in progress.

To test a battery:

1. Check to see that the ZOLL Base PowerCharger <sup>4x4</sup> is connected to live AC mains. The **POWER** light should be lit.

2. Insert a battery into any compartment. Make sure the battery is fully seated (a click can be heard.)

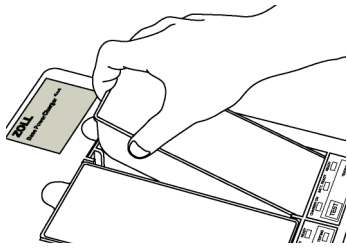

3. Press the **TEST** button for the appropriate compartment. The **TESTING** indicator light will illuminate for the duration of the test cycle.

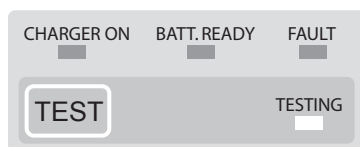

4. If the battery passes the test, the **BATT. READY** light will illuminate while the **TESTING** light remains lit, indicating that the battery is fully charged, ready for use, and has adequate capacity to power an M Series equipped with Pace/Defibrillation and Pulse Oximetry (SpO<sub>2</sub>) for approximately 1.5 hours in Monitor mode.
5. If a battery fails the test, the **FAULT** light will illuminate while the **TESTING** light remains lit. The unit will beep when a battery that has failed capacity test is removed.

To identify the defect, press and hold the **TEST** button while the battery is still in the compartment. Illumination of certain indicator lights together represent a specific defect; see "Fault Codes and Definitions" on page 17 and take corrective action. Repeat test.

Before disposing of the battery, test the battery compartment for possible defective operation (see "Battery Compartment Testing Procedure" on page 16).

6. Record the date and results of the test on the battery label.

**Note:** Interrupting a test cycle in progress by removing the battery will cause an audible warning of five (5) consecutive beeps to indicate that the battery is not fully charged and should not be used. All four indicator lights will illuminate for four (4) seconds and then go off.

## Battery Compartment Testing Procedure

The ZOLL Base PowerCharger 4x4 has four battery compartments that are able to test and charge batteries simultaneously and independently of each other. In addition, the ZOLL Base PowerCharger 4x4 can test each battery compartment for defective operation through the simple press of a button.

To test a battery compartment:

1. Check to see that the unit is connected to live AC mains. The **POWER** light should be lit.
2. Remove battery from compartment to be tested.
3. Press **TEST** button under battery compartment.
4. All four indicator lights will illuminate for approximately 4-5 seconds.
5. If the **TESTING** light and **BATT. READY** light remain lit for three (3) seconds while the other lights go off, the compartment is fully operational without any defects.
6. If the **FAULT** light is lit, the compartment is defective in some way.

To identify the defect, press and hold the **TEST** button. Illumination of certain indicator lights together represent a specific defect. Refer to "Fault Codes and Definitions" on page 17 to identify the fault and take corrective action.

**Note:** Battery compartments operate independently of each other and one faulty compartment may not affect any others. However, there are common failures that can affect all compartments.

## Fault Codes and Definitions

When the **FAULT** indicator light illuminates, press and hold the **TEST** button. The illumination of the following indicator lights together represent a specific defect, identified under the Fault Code column.

CHARGER ON	BATT. READY	FAULT	TESTING	Fault Code
ON	ON	OFF	ON	Temperature
OFF	OFF	ON	OFF	Low Constant Current
ON	OFF	ON	OFF	High Constant Current
OFF	ON	OFF	ON	VCC Voltage
OFF	ON	ON	OFF	Low Power Supply Voltage
ON	OFF	ON	ON	Low Battery Voltage
OFF	ON	ON	ON	High Battery Voltage
ON	ON	ON	ON	Overcharge
OFF	OFF	ON	ON	Battery Capacity
ON	ON	ON	OFF	Discharge Time
ON	OFF	OFF	OFF	Constant Current Voltage
OFF	ON	OFF	OFF	Constant Voltage
ON	ON	OFF	OFF	Discharge
OFF	OFF	OFF	ON	Charger
ON	OFF	OFF	ON	Shutdown

### Definition of Fault Codes

<b>Temperature:</b>	Internal charger temperature deviated from the specified range.
<b>Low Constant Current:</b>	Amount of current during a charge was below the specified range.
<b>High Constant Current:</b>	Amount of current during a charge was above the specified range.
<b>VCC Voltage:</b>	Internal five (5) volt supply deviated from the specified range.
<b>Low Power Supply Voltage:</b>	Charging voltage was measured to be below the specified range.
<b>Low Battery Voltage:</b>	Battery voltage measured was below the specified range.
<b>High Battery Voltage:</b>	Battery voltage measured was above the specified range.
<b>Overcharge:</b>	Total delivered charge exceeded the specified range.
<b>Battery Capacity:</b>	Battery's capacity was measured to be below the specified range.
<b>Discharge Time:</b>	Unit is unable to perform the discharge test.
<b>Constant Current Voltage:</b>	Constant current compliance voltage is below the specified range.
<b>Constant Voltage:</b>	Constant voltage deviated from the specified range.
<b>Discharge:</b>	Test discharge has been ineffective.
<b>Charger:</b>	Safety shutdown (#1) is not operating properly (charge enable).
<b>Shutdown:</b>	Safety shutdown (#2) is not operating properly (shutdown).

**Quick Reference Chart for ZOLL Base PowerCharger 4x4 with AutoTest**

The following chart describes the operation of the ZOLL Base PowerCharger 4x4 with AutoTest. Illumination of specific indicator lights together represent a specific mode of operation, as noted in the **Description** column.

<b>LED OPERATION (AutoTest)</b>					
	<b>CHARGER ON</b>	<b>BATT. READY</b>	<b>FAULT</b>	<b>TESTING</b>	<b>Description</b>
<b>AutoTest with Battery in Compartment</b>	<b>ON</b>			<b>ON</b>	AutoTest is in progress.
		<b>ON</b>			AutoTest is complete and the battery is in good condition.
			<b>ON</b>	<b>ON</b>	AutoTest is complete and the battery is NOT usable.
<b>Manual Test with Battery in Compartment and "TEST" button pushed</b>				<b>ON</b>	Manual Test is in progress.
		<b>ON</b>		<b>ON</b>	Manual Test is complete and the battery is in good condition.
			<b>ON</b>	<b>ON</b>	Manual Test is complete and the battery is NOT usable.

**Note:** If a battery is removed when the **FAULT** light is illuminated, the ZOLL Base PowerCharger 4x4 will beep to indicate the battery has been removed and should NOT be used.

The **POWER** light should be on as long as the unit is plugged into a live AC source.

# Section 4

## Maintenance and Troubleshooting

Following is a list of non-technical operational checks. These checks should be performed periodically to ensure proper equipment operation. If, during this procedure, the operator discovers a malfunction, contact ZOLL Technical Service at 1-800-348-9011 (in Massachusetts: 1-978-421-9655).

### Inspection

Assure that the unit is clean (with no fluid spills) and nothing is stored on the unit.

Inspect all batteries for good condition.

### Cleaning

Clean the ZOLL Base PowerCharger 4x4 with a soft cloth, mild soap and water.

Do not immerse any part of the ZOLL Base PowerCharger 4x4 in water. Do not use alcohol or ketones (MEK, acetone, etc.). Do not autoclave the ZOLL Base PowerCharger 4x4.

### Operational Checks

1. Connect the unit to live AC mains. All four indicator lights will illuminate for approximately 4-5 seconds. The **POWER** indicator light will remain lit while the other lights go off.
2. With all battery compartments empty, check that all indicator lights except **POWER** are off.
3. Press the **TEST** button under each compartment to verify that the compartments are fully operational (see "Battery Compartment Testing Procedure" on page 10).
4. Insert a battery into each compartment. Verify that the **CHARGER ON** light illuminates immediately.

### Changing the AC Line Setting of the ZOLL Base PowerCharger 4x4

The ZOLL Base PowerCharger 4x4 can be set for line voltages of 100 V, 120 V, 220 V, and 240 V. The voltage wheel can be found within the Power Module located on the rear plate of the ZOLL Base PowerCharger 4x4. To set the unit to a different line voltage than the voltage shipped, perform the following steps:

1. Insert a screwdriver into the slot on the Power Module and twist to open the door.

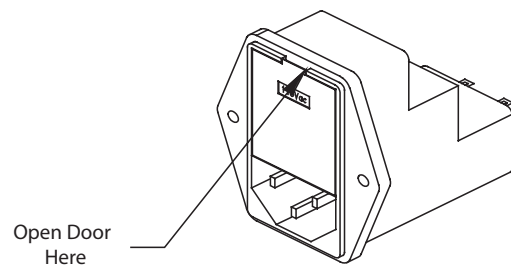

2. Remove the voltage drum from the Power Module by pulling straight out. Set the voltage drum to the appropriate voltage setting by turning the voltage drum.

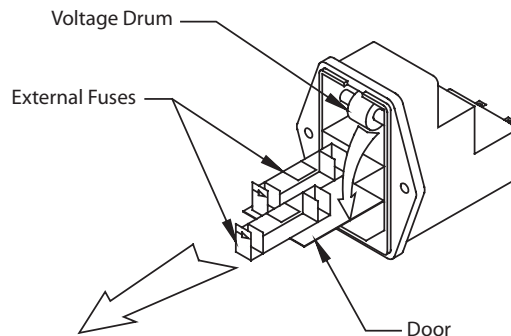

3. Place the voltage drum back into the Power Module. Close the door. Make sure the voltage setting appears in the window of the door.

### Troubleshooting

The troubleshooting guide provided below is intended for use by non-technical personnel during operation. This section addresses many of the common problems or questions that arise during operation.

If trouble persists after consulting this guide, contact the ZOLL Technical Service Department.

1. **POWER** indicator light does not illuminate.
  - Check that unit is plugged into an appropriate power source.
  - Check for defective power cord.
  - Plug unit into another power source.
  - Check for blown fuse.
2. **CHARGER ON** indicator light does not illuminate when battery is in compartment.
  - Check that battery is properly seated in compartment.
  - Check that battery contacts are clean and not damaged.
  - Check that unit is plugged into an appropriate power source.
  - Test the battery compartment for proper functionality.
  - Place another battery in the compartment.
3. **TESTING** light does not illuminate when **TEST** button is pressed.
  - Check that battery is properly seated in compartment.
  - Check that unit is plugged into an appropriate power source.
4. Battery fails test cycle (**FAULT** light illuminates with **TESTING** light).
  - Verify that battery compartment is fully operational with no defects.
  - Repeat test cycle.



# Section 5

## Battery Management

Safe, reliable use of all ZOLL devices requires a well-designed battery management program to ensure that adequate battery power is always available.

The 6 key steps to developing a battery program are:

1. Obtaining proper equipment.  
Plan to have a sufficient number of battery packs and chargers to insure an adequate supply of fully charged primary use and spare use batteries.
2. Assigning a responsible individual.  
Assign the responsibility to an individual who can oversee all aspects of the program as well as educate other ZOLL Monitor/Defibrillator users.
3. Defining battery exchange and charging routines.  
Clinical and technical staff should determine desired use patterns and an optimum sequence to insure consistent charging and exchange routines.
4. Ensuring sufficient spare battery capability.  
A fully-charged spare battery should be kept immediately available with all ZOLL Monitor/Defibrillator devices. The availability of more than one spare battery is recommended in cases where prolonged or repeated use of the device may be required, such as long transport situations.
5. Developing backup procedures.  
Procedures to maintain appropriate life support (such as cardiopulmonary resuscitation) should be pre-planned in the event that a device fails and another battery or device must be sought.
6. Testing batteries regularly.  
Develop a testing schedule as part of your organization's battery management program. The appropriate frequency of testing depends on the age of the battery pack and the frequency and type of use. As the battery ages, testing should be more frequent since failure will occur rapidly at the battery's end-of-life. At a minimum, ZOLL recommends testing every three months. For additional information on Battery Management, refer to the ZOLL Battery Management Program (part number 9650-0019).

### ZOLL Battery Packs

ZOLL PD 4410/Smart/Smart Ready Battery and XL Battery Packs are five-cell assemblies of sealed lead-acid batteries specifically designed for use with all ZOLL Monitor/Defibrillator devices.

Lead acid battery packs require full recharging after use. Continuous short cycle recharging will result in reduced capacity and early battery pack failure.

### Battery Life Expectancy

Frequency of use, number of batteries used, and the pattern of discharging and recharging batteries contribute to the loss of battery charge capacity. Because of this, ZOLL recommends that operators replace and discard used batteries on a preventive, scheduled basis. The most effective preventive replacement interval should be based on anticipated use patterns, battery pack testing results and experience with the device in actual operation. ZOLL recommends battery replacement every eighteen months or sooner.

For more information about such a schedule, contact your ZOLL Technical Service Representative.

### Low Battery Message

As individual battery capacity diminishes, the amount of operating time remaining after a LOW BATTERY message also diminishes. For newer or lesser-used batteries, the operating time remaining after this warning will be significantly longer than the operating time remaining on batteries that have seen more use. In either case, this warning will ultimately lead to defibrillator shut-off, and consequently, the low battery should be replaced with a fully-charged battery as soon as possible.

When a LOW BATTERY message is displayed, replace the battery pack immediately to ensure continuous operation.

### Battery Disposal

Place the battery in an acid resistant container. Dispose of the battery in accordance with federal, state, and local regulations. Do not incinerate batteries. Batteries should be shipped to a reclamation facility for recovery of metal and plastic compounds as the proper method of waste management.

(This page intentionally left blank.)



**Worldwide Headquarters**

269 Mill Road  
Chelmsford, MA 01824-4105  
U.S.A.  
Telephone: (978) 421-9655  
Toll Free: (800) 348-9011  
Telefax: (978) 421-0025

**Europe Regional Office**

Edisonring 3a  
6669 NA Dodewaard  
Netherlands  
Telephone: + 31-488-41-1183  
Telefax: + 31-488-41-1187

**ZOLL Medical France**

189, Rue Nationale 10  
78310 Coignieres  
FRANCE  
Telephone: + 33 1 30 05 14 95  
Telefax: + 33 1 30 49 06 93

**Far East Regional Office**

81 Excelsior Street  
Lisarow 2250  
NSW  
Australia  
Telephone: + 61-2-432-922-26  
Telefax: + 61-2-432-922-26

**Latin America Regional Office**

6468 NW 75<sup>th</sup> Way  
Parkland, FL 33067  
USA  
Telephone: + 954-345-4224  
Telefax: + 954-345-2648

**ZOLL Medical U.K. Ltd.**

European Authorized Representative  
Stephen Smith  
49 Melford Court  
Woolston, Warrington  
Cheshire WA1 4RZ  
Telephone: + 44-192-584-6400  
Telefax: + 44-192-584-6401

**ZOLL Medical Deutschland GmbH**

Schillingsrotter Str. 23  
50996 Köln  
Deutschland  
Telephone: + 49-221-3989-340  
Telefax: + 49-221-3989-336

**Middle East/Africa Regional Office**

#14 Persefonis  
Ekali 14578  
Athens, Greece  
Telephone: + 971-50-6531504  
Telefax: + 30 10 813 0580

**ZOLL Medical Canada**

5266 General Road  
Unit #15  
Mississauga, Ontario L4W 1Z7  
Telephone: (905) 629-5005  
Toll Free: (866) 442-1011  
Telefax: (905) 629-0575

**ZOLL Medical Australia Pty. Ltd**

Unit 4, 12 Chaplin Dr.  
Lane Cove  
NSW 2066  
Australia  
Telephone: + 61-2-94208733  
Telefax: + 61-2-94209834