

**D-Tec Vaporizer** Operation and Maintenance Manual

# User Responsibility

---

This Product will perform in conformity with the description thereof contained in this operating manual and accompanying labels and/or inserts, when assembled, operated, maintained and repaired in accordance with the instructions provided. This Product must be checked periodically. A defective Product should not be used. Parts that are broken, missing, plainly worn, distorted or contaminated should be replaced immediately. Should such repair or replacement become necessary, Datex-Ohmeda recommends that a telephonic or written request for service advice be made to the nearest Datex-Ohmeda Field Service Support Center. This Product or any of its parts should not be repaired other than in accordance with written instructions provided by Datex-Ohmeda and by Datex-Ohmeda trained personnel. The Product must not be altered without the prior written approval of Datex-Ohmeda's Quality Assurance Department. The user of this Product shall have the sole responsibility for any malfunction which results from improper use, faulty maintenance, improper repair, damage, or alteration by anyone other than Datex-Ohmeda.

---

## CAUTION

⚠ U. S. Federal and Canadian law restrict this device to sale by or on the order of a licensed medical practitioner. Outside the U. S. A. and Canada, check local laws for any restrictions that may apply.

---

Datex-Ohmeda products have unit serial numbers with coded logic which indicates a product group code, the year of manufacture and a sequential unit number for identification.

AAA A 12345

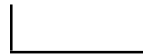

This alpha character indicates the year of product manufacture and when the serial number was assigned; "Y" = 1995, "Z" = 1996, "A" = 1997, etc. "I" and "O" are not used.

---

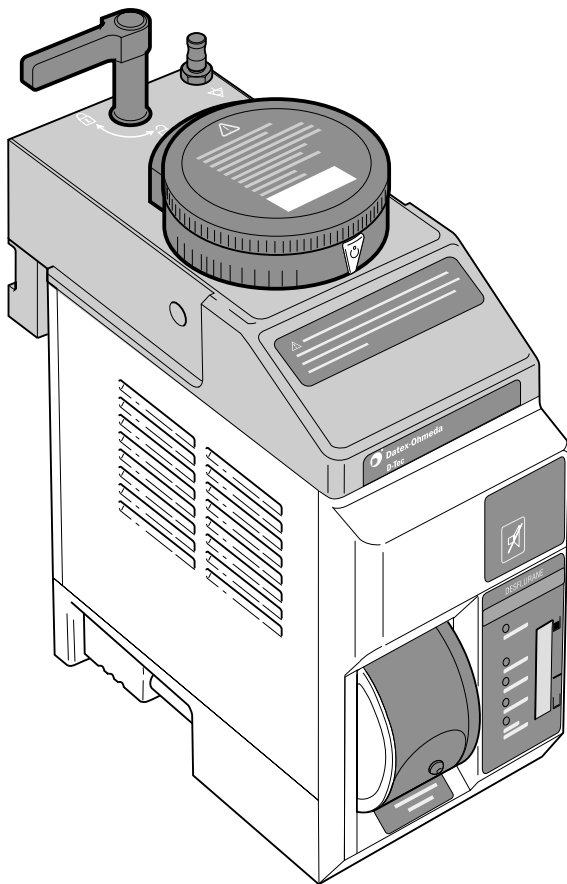

---

**D-Tec Vaporizer**

# Contents

<b>1.0</b>	<b>Introduction</b>	<b>1</b>
1.1	Operation And Maintenance Manual	1
1.2	Precautions	1
1.3	Symbols	2
<b>2.0</b>	<b>Description</b>	<b>2</b>
2.1	General	2
2.2	Component Information	4
2.2.1	Power Supply Unit	4
2.2.2	Filler Assembly	4
2.2.3	Drain Plug	4
2.2.4	Power Supply Connector And Battery	4
2.2.5	Equi-Potential Stud	5
2.2.6	Sump	5
2.2.7	Heater Elements	5
2.2.8	Monitors	5
2.2.9	Agent Level Sensor	5
2.2.10	Tilt Switch	5
<b>3.0</b>	<b>Controls And Indicators</b>	<b>6</b>
3.1	Dial Assembly	6
3.2	Auditory And Visual Indicators	6
3.3.2	Operational	7
3.3.3	Agent Level Display	7
3.3	Status Display	7
3.3.1	Warm-Up	7
3.3.4	Low Agent Level	8
3.3.5	No Output	8
3.3.6	Alarm Battery Low	8
<b>4.0</b>	<b>Vaporizer Preparation</b>	<b>9</b>
4.1	Fitting The Battery And The Mains Lead	9
4.2	Vaporizer Installation	10
<b>5.0</b>	<b>Operating Instructions</b>	<b>11</b>
5.1	Alarm And Display Test	11
5.2	Preoperative Checkout	12
5.3	Turning The Dial To The Required Setting	13
5.4	Filling The Vaporizer	14
5.4.1	General	14
5.4.2	Filling Procedure	14
<b>6.0</b>	<b>Maintenance</b>	<b>16</b>
6.1	Cleaning	16
6.1.1	External Cleaning	16
6.1.2	Internal Contamination	16
6.3	Spare Parts	17
6.2	Changing The Battery	17

<b>7.0</b>	<b>Principle Of Operation (Fig. 19)</b>	<b>18</b>
7.1	Alarm And Indicator Display	18
7.2	Delivery Of Gas/Agent Vapor	18
<b>8.0</b>	<b>Fault Diagnosis</b>	<b>20</b>
<b>9.0</b>	<b>Specification</b>	<b>22</b>
9.1	Calibration	22
9.2	Electrical Supplies	22
9.3	Performance	22
9.4	Classification	23
9.5	Weight And Dimensions	23
9.6	Flow Characteristics	23
9.7	Effects Of Output At Varied Altitudes	24
9.8	Effects Of Ambient Temperature	24
9.9	Effects Of Back Pressure	24
9.10	Effects Of Carrier Gas Composition	24
<b>10.0</b>	<b>Warranty</b>	<b>25</b>
<b>11.0</b>	<b>Servicing Policy</b>	<b>26</b>
	<b>Index</b>	<b>27</b>

## Illustrations

Fig. 1	Filler Assembly	4
Fig. 2	Vaporizer Base	4
Fig. 3	Dial Assembly	6
Fig. 4	Front Display Panel	6
Fig. 5	Warm-Up	7
Fig. 6	Operational	
Fig. 7	Low Agent Level	8
Fig. 8	No Output	8
Fig. 9	Alarm Battery Low	8
Fig. 10	Fitting The Battery	9
Fig. 11	Fitting The Mains Lead	10
Fig. 12	Mounting The Vaporizer Onto A Manifold	11
Fig. 13	Locking The Vaporizer Onto A Manifold	11
Fig. 14	Routing The Mains Lead	12
Fig. 15	Unlocking The Vaporizer From A Manifold	12
Fig. 16	Alarm And Display Test	13
Fig. 17	Amber WARM-UP Light	13
Fig. 18	Green OPERATIONAL Light	14
Fig. 19	Turning The Vaporizer Dial	15
Fig. 20	Inserting The Bottle	16
Fig. 21	Filling The Vaporizer	17
Fig. 22	Changing The Battery	19
Fig. 23	Vaporizer Schematic	21

# 1.0 Introduction

## 1.1 Operation And Maintenance Manual

This Operation And Maintenance (O & M) Manual contains the information required in order to install, operate and maintain the D-Tec Vaporizer.

Maintenance procedures are restricted to those detailed in Section 6.0 of this manual.

Requests for servicing facilities, advice or assistance must be addressed either to a local Datex-Ohmeda Office or to an Datex-Ohmeda Authorized Distributor.

Additional copies of this manual, quoting Datex-Ohmeda D-Tec Vaporizer O & M Manual Part No. 1107-0622-000, can be requested from a local Datex-Ohmeda Field Operations Unit or from an Datex-Ohmeda Authorized Distributor.

It is recommended that all relevant documentation, including the O & M Manual and accompanying labels, is immediately available to all prospective operators.

## 1.2 Precautions

A number of Warnings and Cautions are used throughout this manual to draw attention to the possible hazards and/or adverse conditions which may occur if the information and instructions provided are not strictly observed.

Cautions and Warnings are preceded by a  symbol and are used to draw attention to a condition which can endanger either the patient or the operator and can result in damage to the equipment.

Special attention must be paid to each Warning and Caution as it appears in the manual.



**Warning: Do not fill the vaporizer with any substance other than Suprane™ (desflurane) as specified on the front label. If any substance other than Suprane™ (desflurane) is used, patient injury could occur.**



**Warning: U.S. Federal and Canadian law restrict this device to sale by or on the order of a licensed medical practitioner.**













**Warning: Before using the D-Tec Vaporizer, the Suprane™ (desflurane) package insert must be studied. Failure to conform to the recommendations on the insert may result in patient injury.**

### **Important:**

The vaporizer manifold O-rings required for your NAD / Dräger anesthesia machine are dependent on the place of manufacture of the anesthesia machine vaporizer manifold. Datex-Ohmeda cannot determine the specific requirements of your NAD / Dräger anesthesia machine. Therefore, per a written request from Dräger Medical, Inc., this D-Tec series vaporizer does not include replacement O-rings for the anesthesia machine vaporizer manifold. Please contact your Dräger Medical representative to obtain the correct O-rings for your system.

## 1.3 Symbols

Symbol	Location	Facility/Rating
	Control Dial	Standby setting
	Interlock Block	Setting mark - dial marking alignment point for required setting
	Interlock Block	Equi-potential stud - connection for minimizing electrical potential difference
	Front Panel	Auditory alarm mute button
	Display Panel	240 ml refill mark - indicates that an additional 240 ml of agent can be added
	Display Panel	Symbolizes nominal agent level display when 390 ml of agent in sump (max.)
	Display Panel	Symbolizes nominal agent level display when only 60 ml of agent in sump (min.)
	Rear Label	Mains electrical supply must be single phase sinusoidal alternating current
	Top Plate Label	Direction of flow
	Various	Warning

## 2.0 Description

### 2.1 General

The D-Tec Vaporizer is designed to add Suprane™ (desflurane) inhalant anesthetic vapor to the medical gases supplied to a patient. The vaporizer must only be mounted on a Dräger compatible anesthesia machine which is equipped with an interlocking type manifold. The vaporizer must be supplied with dry medical gas and it must be connected to a suitable electrical mains supply. However the D-Tec vaporizer cannot be used on the Narkomed Mobile anesthesia system.

The D-Tec Vaporizer is designed to meet UL 2601-1, IEC 601-1 and IEC 601-2-13 recommendations.

When the vaporizer is connected to the electrical supply, the dial is turned to the  (Stand-by) symbol and the green OPERATIONAL light located on the front display panel is illuminated, the vaporizer is in the electrical stand-by condition and is ready for use, as described in Section 5.0 Operating Instructions.

Mechanical and electrical interlocks are incorporated into the vaporizer to help ensure that the following criteria are satisfied:

1. The vaporizer dial can only be turned from  $\odot$  when the vaporizer is locked onto the manifold and the green OPERATIONAL light is illuminated to indicate that the vaporizer has attained the correct operating temperature.
2. The gas flow only enters the vaporizer which is in operation.
3. Unwanted anesthetic trace vapor is minimized after a vaporizer is turned to  $\odot$ .

*Note: It is a requirement of the ASTM standard F1850-98 and European Standard EN 740 - Anaesthetic Workstations And Their Modules, that an appropriate gas monitor is used to monitor the concentration of anaesthetic agent vapor in the inspiratory gas when the vaporizer is in operation, in order to provide protection against hazardous output in the event of a device malfunction.*



**Warning:** This manual and all its associated documentation must be studied before any attempt is made to install, operate or clean any part of the D-Tec Vaporizer.



**Warning:** The performance of the anesthetic machine and vaporizer may be degraded if the machine and vaporizer are mismatched.



**Warning:** Do not install a D-Tec vaporizer in the right hand position of a Narkomed 6000 as this will result in an incorrect fit and may cause leaks in the fresh gas delivery system.



**Warning:** To avoid explosive hazards, flammable anesthetic agents such as Ether and Cyclopropane must not be used in this vaporizer. Only anesthetic agents which comply with the requirements for non-flammable anesthetic agents in the IEC 601-2-13 Standard, particular requirements for the safety of anesthesia machines, are suitable for use in the presence of this vaporizer.



**Warning:** As this vaporizer is not suitable for use with flammable anesthetic agents such as Ether or Cyclopropane, the use of antistatic breathing tubes and face masks is not necessary. The use of antistatic or electrically conductive breathing tubes when utilizing high frequency electric surgery equipment may cause burns and is therefore not recommended in any application of this vaporizer.



**Warning:** The functioning of this vaporizer may be adversely effected by the operation of equipment such as high frequency surgical apparatus or short-wave therapy equipment in the vicinity.



**Warning:** Do not operate the vaporizer other than with dry medical gases.



**Warning:** The D-Tec Vaporizer must not be used in a Magnetic Resonance Imaging environment.



**Warning:** The functioning of this D-Tec vaporizer may be adversely affected by electromagnetic interference exceeding the levels specified in EN 60601-1-2.



**Warning:** This product contains a small quantity of Mercury in the Tilt Switch mechanism and should be disposed of according to local regulations.



**Caution:** If the vaporizer is not likely to be used for a period of 12 months, the battery must be removed. Failure to do so may result in damage to the vaporizer.



**Caution:** 'No Output' alarm could be caused by downstream high frequency ventilation at greater than 60 breaths/min with an airway pressure of 100 cm H<sub>2</sub>O or pulsing the O<sub>2</sub> flush faster than 1 pulse/sec over a time period of greater than 10 secs.



**Caution:** Refer to the User's Manual for the Dräger Julian Anaesthesia Workstation for recommended ventilator parameter limitations when using the D-Tec with a Julian.



## 2.2 Component Information

### 2.2.1 Power Supply Unit

The D-Tec Vaporizer uses a 100 to 120V a.c. 50/60 Hz electrical supply model. A label on the rear panel of the vaporizer states the voltage requirement for each model.

The integral power supply unit consists of a transformer and an a.c. to d.c. converter which provides the 12V d.c. and 5V d.c. supplies for the electrical system.

### 2.2.2 Filler Assembly

The filler assembly, illustrated on Fig. 1, incorporates an agent specific fitting which helps to ensure that only a Suprane™ (desflurane) specific bottle equipped with a "Saf-T-Fill"™ valve can be inserted in order to fill the vaporizer.

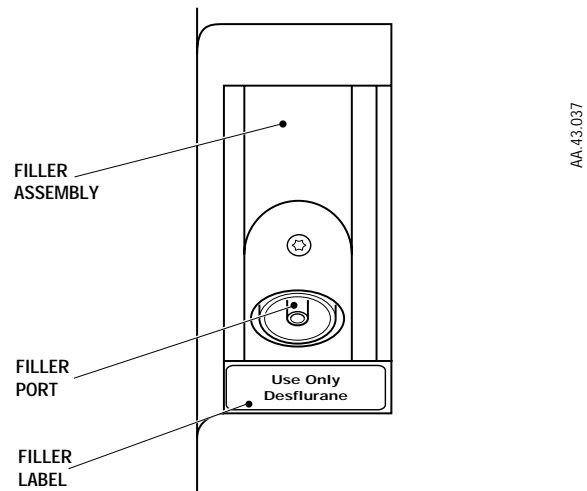

Fig. 1 Filler Assembly

### 2.2.3 Drain Plug



**Warning:** Draining the vaporizer may result in rapid loss of pressure and/or agent which could lead to injury to the operator.

A drain plug is located at the base of the vaporizer as illustrated on Fig. 2. The drain plug must not be removed except at an Datex-Ohmeda Authorized Service Center.

### 2.2.4 Power Supply Connector And Battery

The electrical power supply connector is located in the base of the vaporizer as illustrated on Fig. 2.

If the mains power supply fails, a Duracell 1604 or VARTA Energy 2000 battery incorporated in the base of the vaporizer provides power for the auditory and visual alarms only. The battery must be replaced annually.

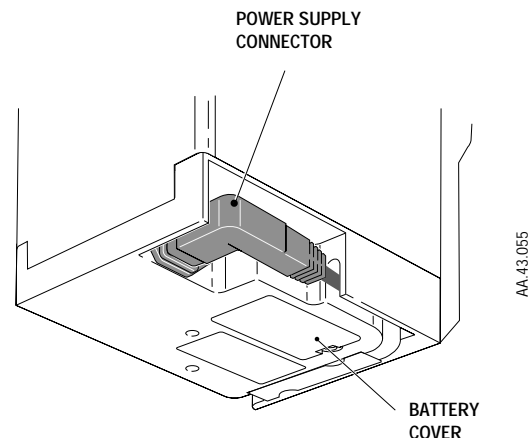

Fig. 2 Vaporizer Base

### **2.2.5 Equi-Potential Stud**

The equi-potential stud  $\nabla$  is located on the top of the vaporizer. It provides a means of connecting a vaporizer to the anesthesia system to minimize any electrical potential difference between the vaporizer casing and the anesthesia system.

### **2.2.6 Sump**

The sump provides a means of containing the agent and includes the agent filling port, the drain, the heaters and the agent level sensor.

The sump has a total nominal capacity of 390 milliliters (ml) which consists of a nominal 330 ml indicated volume and a nominal 60 ml reserve.

### **2.2.7 Heater Elements**

Two 100W heater elements, located in the base of the sump, heat the agent to a nominal 39°C (102°F) to generate the working pressure.

Two 100W heater elements located in the upper part of the vaporizer help to prevent condensation of the anesthetic agent in the vaporizer.

The current supplied to power the heaters alternates between the two heaters in the sump and the two heaters in the upper part of the vaporizer. This minimizes the current requirement.

The casing of the vaporizer is normally warm to the touch while it is connected to the electrical supply.

### **2.2.8 Monitors**

Electro/mechanical monitors are incorporated to monitor the fresh gas/agent vapor pressure balance and the agent volume.

The monitors control the operational status display and activate the appropriate alarm indication if a monitored parameter malfunction is detected.

### **2.2.9 Agent Level Sensor**

An agent level sensing probe is mounted in the sump to measure the agent level. When the sump contains between 60 and 390 ml of agent, the LCD level display indicates the level of agent in the sump. If the agent level decreases below 60 ml, the amber LOW AGENT light on the display panel flashes and the auditory alarm is activated. If the agent level decreases below approximately 20 ml, the red NO OUTPUT light flashes and the auditory alarm is activated. Vapor output then ceases.

### **2.2.10 Tilt Switch**

If the vaporizer is tilted for 10-15 seconds while it is in operational mode and delivering vapor, vapor delivery will be stopped, as indicated by the flashing No Output light and auditory alarm.

## 3.0 Controls And Indicators

### 3.1 Dial Assembly

The manually operated dial is used to select the level of agent concentration from 1% to 18%. The dial is marked at intervals of 1% from 1% to 10% and at intervals of 2% from 10% to 18%. Selections can be made at any setting between 1% and 18%.

The dial release incorporated in the dial assembly must be operated in order to turn the dial from the  $\odot$  (Standby) setting and it must be operated again to turn the dial from 12% to a higher % setting. All other settings can be made without operating the dial release.

A solenoid interlock mechanism is also incorporated to help to ensure that the dial can be operated only when the green OPERATIONAL light located on the display panel is illuminated.

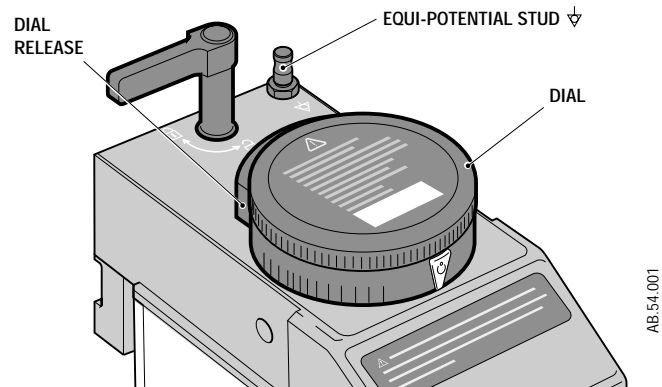



Fig. 3 Dial Assembly

### 3.2 Auditory And Visual Indicators

Visual indicators and an auditory alarm are used to provide the vaporizer status display and also to indicate an alarm condition, as described in Section 3.3.

Visual indicators are located on the front display panel illustrated in Fig. 4 and the auditory alarm is mounted behind the upper part of the front display panel.

An auditory alarm mute button  located above the display panel can be used to mute the alarm temporarily under certain conditions as described in Sections 3.3, 3.3.4 and 3.3.5.

The LCD agent level display indicates the level of agent contained in the vaporizer sump, as described in Section 3.3.3. The range of indication is between a minimum of 60 ml and a maximum of 390 ml. When the indication is below the 240 ml refill mark , it indicates that an additional 240 ml of agent can be added.

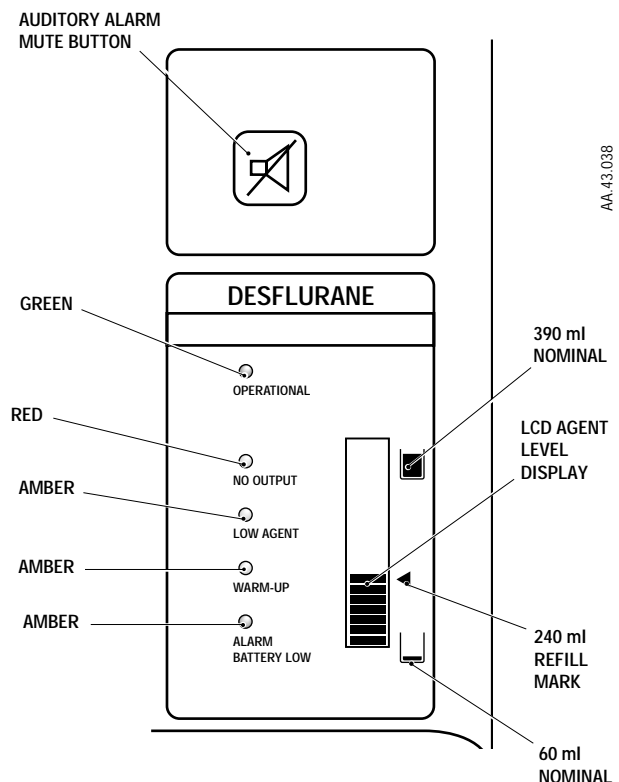





Fig. 4 Front Display Panel

### 3.3 Status Display

The display panel lights and the auditory alarms operate as follows to indicate the operational status of the vaporizer:

*Note: If the dial is at the  setting when an alarm occurs, the auditory alarm is activated and the light indicating the alarm condition flashes. When the  is pressed, the auditory alarm is muted and the light is continuously illuminated.*

#### 3.3.1 Warm-Up

The amber WARM-UP light is continuously illuminated when the vaporizer is in its warm-up mode. The dial cannot be turned from  when the vaporizer is in its warm-up mode.

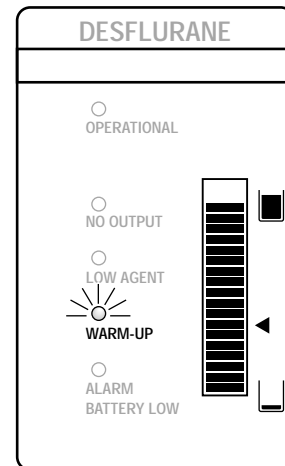

AA-43.039



Fig. 5 Warm-Up

#### 3.3.2 Operational

The green OPERATIONAL light is continuously illuminated when the vaporizer is in its operational mode. The dial can be turned from the  setting when the vaporizer is in the operational mode.

#### 3.3.3 Agent Level Display

The LCD agent level display consists of a series of bars which indicate the nominal volume of agent in the vaporizer sump.

The  symbol denotes a 390 ml volume of agent and the  symbol denotes a 60 ml volume of agent in the sump.

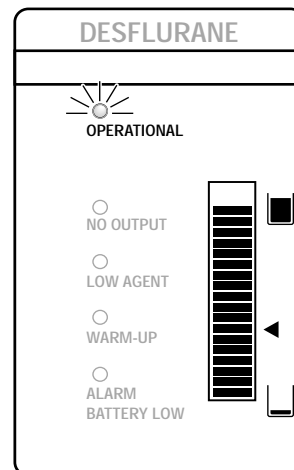

AA-43.040

Fig. 6 Operational

As the sump fills, the first agent level indicating bar appears in the LCD volume display when there is between 60 and 80 ml of agent in the sump. As the level increases more bars are displayed as illustrated on Fig. 6 and as the level decreases less bars are displayed.

When the bars are either level with or below the , the sump can accommodate 240 ml of agent, which is one full bottle. When there are no bars visible, as illustrated on Fig. 7, the Low Agent Level alarm is activated as described in Section 3.3.4.

*Note: The agent level display is calibrated to be most accurate when the vaporizer is in a perfectly level position. Deviations from a level position affect the accuracy of the agent level display and may activate the LOW AGENT level alarm.*

### 3.3.4 Low Agent Level

The amber LOW AGENT light flashes accompanied by a long tone operation of the auditory alarm which is a repetitive 1.5 seconds ON and 0.5 seconds OFF. The alarm indicates that there is less than 60 ml of agent remaining in the sump.

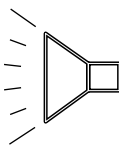

Pressing the  mutes the auditory alarm for a period of 120 seconds to allow time to fill the vaporizer to above 60 ml.

If a LOW AGENT condition occurs during normal operation, the alarm is activated but the green OPERATIONAL light remains illuminated.

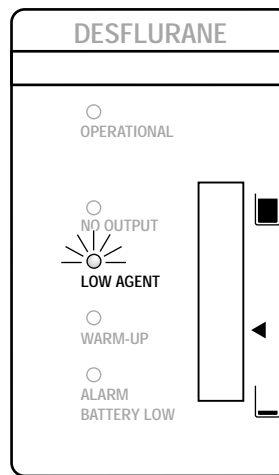
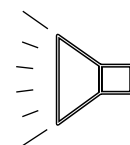

Fig. 7 Low Agent Level

AA-43.041

### 3.3.5 No Output

The NO OUTPUT alarm is activated if any one of the following occurs:



1. The agent level decreases to below 20 ml.
2. The vaporizer is tilted.
3. A power failure of longer than 10 seconds duration occurs.
4. An internal malfunction is detected.

The alarm consists of a flashing red NO OUTPUT light accompanied by short tone operation of the auditory alarm which is a repetitive 0.5 seconds ON and 0.5 seconds OFF. The alarm indicates that the vaporizer has closed down and is no longer delivering any vapor.

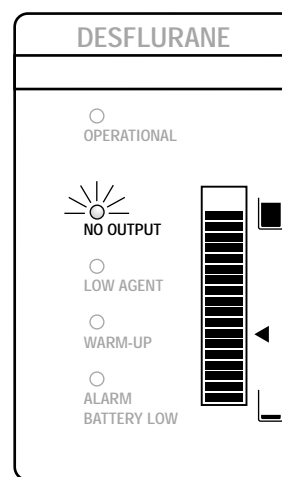





Fig. 8 No Output

AA-43.042

If the NO OUTPUT alarm occurs while the vaporizer is in use, the vaporizer dial must be turned to . This mutes the auditory alarm and illuminates the red light continuously. Either an alternative vaporizer or an alternative method of anesthesia must be used.

If the NO OUTPUT alarm is activated as a result of a power failure and the dial is at  when the power supply is restored, the alarm and display test is activated and then the vaporizer returns to either the WARM-UP or the OPERATIONAL mode.

If the dial is not at  when the power supply is restored, the NO OUTPUT alarm continues and can only be cancelled by turning the dial to . In this condition the alarm and display test is not activated and the vaporizer returns to either the WARM-UP or the OPERATIONAL mode after a 10 second delay.

### 3.3.6 Alarm Battery Low

The amber ALARM BATTERY LOW light continuously illuminates to indicate that the alarm battery voltage is low. A new battery must be fitted within eight hours to support the NO OUTPUT alarm in the event of a subsequent mains failure condition. There is no auditory alarm in the ALARM BATTERY LOW condition.

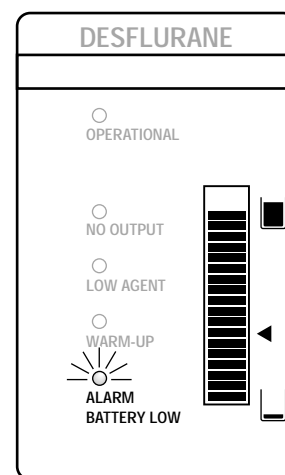

Fig. 9 Alarm Battery Low

AA-43.043

## 4.0 Vaporizer Preparation

### 4.1 Fitting The Battery And The Mains Lead



Caution: Do not support the vaporizer by holding the control dial and/or locking lever. Hold the main body of the vaporizer with both hands and keep the vaporizer in an upright position. Failure to do so may cause the vaporizer to malfunction.



Caution: Only a Duracell 1604 or VARTA Energy 2000, 9 Volt battery must be installed in the vaporizer. If any other battery is installed, it may damage the vaporizer.



Warning: The battery terminals must be firmly clipped onto the battery to help prevent a possible disconnection when the vaporizer is moved.



Warning: Only a Datex-Ohmeda mains lead must be used to connect the vaporizer to the electrical supply.



Warning: When routing the mains lead to the electrical supply, ensure that it does not interfere with the correct functioning of other equipment.

The new battery and the mains lead supplied with the vaporizer must be fitted during initial installation as detailed in Instructions 1, 2 and 3, therefore Instructions 1, 2 and 3 can be ignored if a battery and mains lead are already fitted.

1. Invert the vaporizer, unscrew the battery cover securing screw and remove the battery cover from the base of the vaporizer as illustrated on Fig. 10.
2. Clip the battery terminals firmly onto the new battery observing the correct polarity. Insert the battery into the vaporizer, fit the battery cover to the base of the vaporizer and tighten the securing screw.

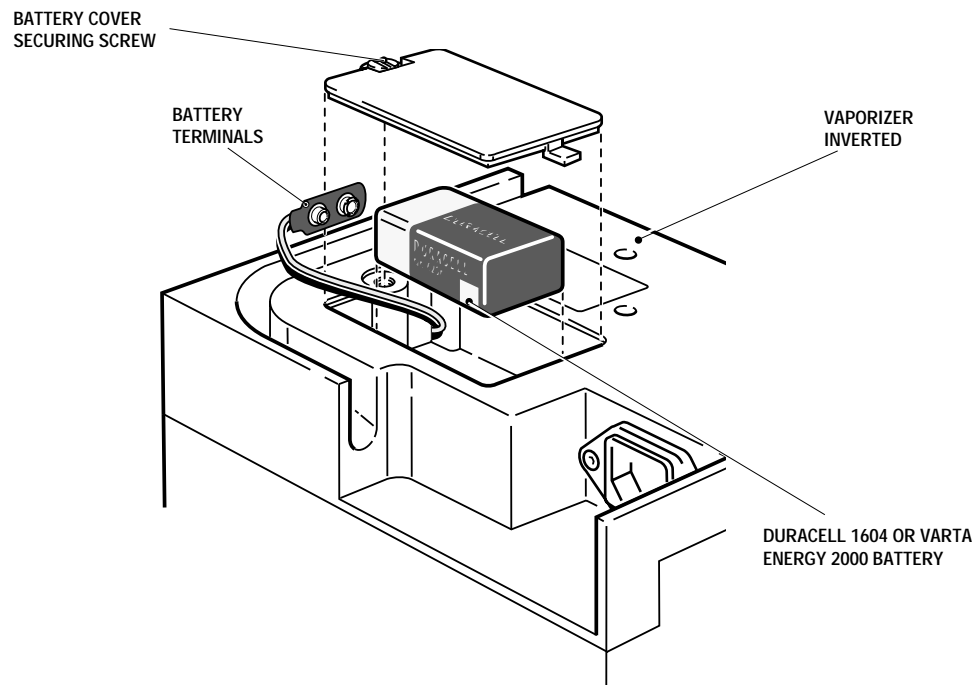

Fig. 10 Fitting The Battery

3. Remove the mains lead retaining plate illustrated on Fig. 11 and fit the Datex-Ohmeda mains lead firmly into the socket of the vaporizer. Feed the mains lead into the mains lead channel and then clip the mains lead retaining plate back into the base.
4. Feed the lead round the back of the vaporizer.

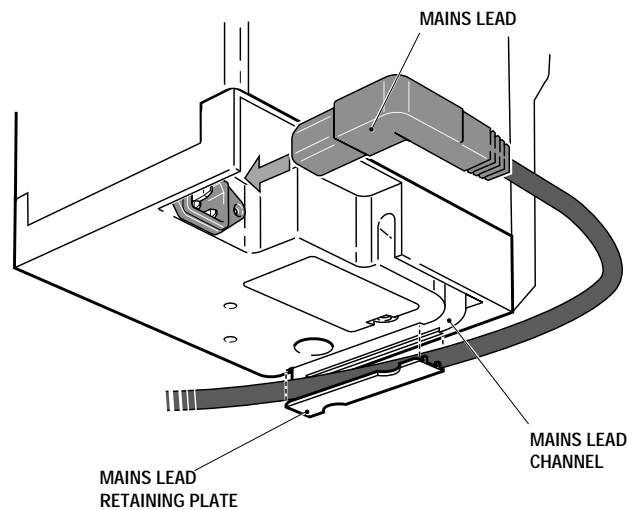

Fig. 11 Fitting The Mains Lead

AB.54.002

## 4.2 Vaporizer Installation

### Connecting the vaporizer to the plug-in system



**Caution: Use only the Dräger plug-in system!**

1. Set the control dial to the  position.
  - On commissioning only:
    - Remove protective plugs from vaporizer's ports.
2. Install the 'O' rings, if necessary, as described in the relevant anesthesia machine operation and maintenance manual.

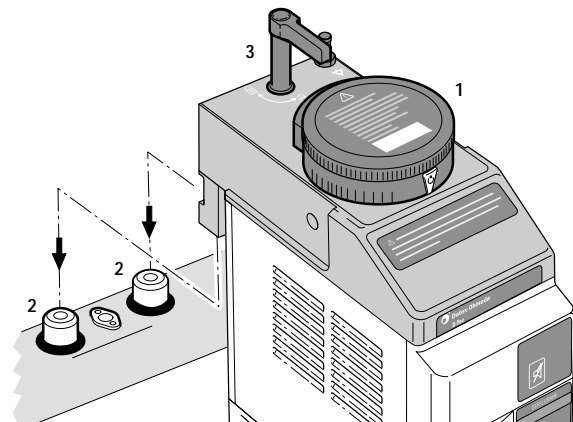

AB.54.010

3. The locking lever must be set to the "unlocked" position.
  - With both hands, hold the main body of the vaporizer in an upright position and lower it on to the plug-in system, ensuring that the vaporizer ports correctly engage the plug-in system port valves.
  - To lock the vaporizer, turn the locking lever 90° in a clockwise direction.

The vaporizer should lie positioned horizontally on the plug-in system.



**Warning: Do not install a D-Tec vaporizer in the right hand position of a Narkomed 6000 as this will result in an incorrect fit and may cause leaks in the fresh gas delivery system.**

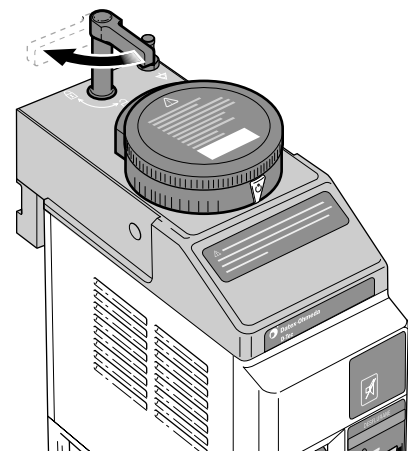

AB.54.009

## Fitting the equi-potential lead

- e.g. for intracardiac
- Fit one end of the lead to the equi-potential stud on the D-Tec.
  - Route and connect the other end of the lead to a central ground stud, as described in the relevant anesthesia machine Operation and Maintenance Manual.

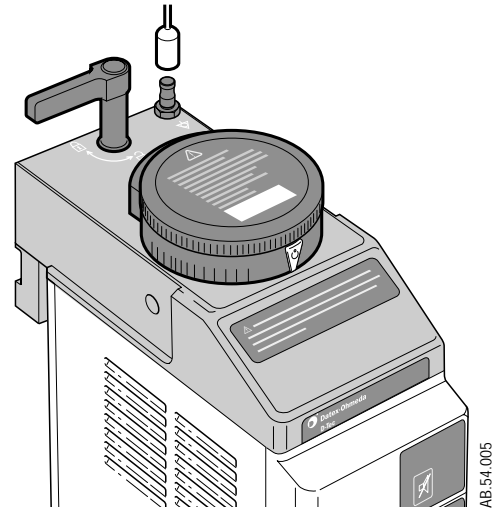

## 5.0 Operating Instructions

### 5.1 Alarm And Display Test



**Warning:** Only use vaporizers which are in a serviceable condition.



**Caution:** Allow the vaporizer to attain its specified ambient operating temperature before connecting it to a mains power supply.

1. Connect the mains lead from the vaporizer to an approved hospital grade outlet socket.



**Warning:** Do not use the vaporizer if during the alarm and display test any one of the five lights and all the LCD agent level indicator bars do not flash or the auditory alarm does not operate for a period of approximately two seconds.

2. Verify that the alarm and display test is automatically operated for a period of approximately two seconds as follows:

- a) Each light and all the LCD agent level indicator bars on the front display panel flash four times.
- b) The auditory alarm is activated four times.

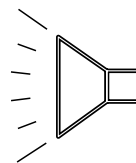

3. The alarm and indicators can be tested at any time by pressing the  for at least four seconds to activate the alarm and display test. Activating the test does not affect the operation of the vaporizer.
4. The alarm and display test is designed to test the lights, the LCD bars and the auditory alarm. If any of the lights, the LCD bars and/or the auditory alarm fail to operate, do not use the vaporizer.

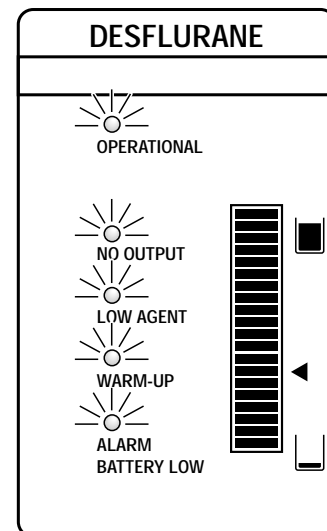

Fig. 12 Alarm And Display Test





**Caution:** If there are no LCD bars visible and the amber LOW AGENT light is illuminated after the alarm and display test is completed, there is less than 60 ml of agent in the sump and the vaporizer must be filled as described in Section 5.4.

5. If the LOW AGENT light remains illuminated after the alarm and display test is completed, fill the vaporizer as described in Section 5.4.
6. If there is sufficient agent in the sump, check that each light is extinguished, except the amber WARM-UP light which indicates that the vaporizer is in its warm-up condition. If the vaporizer is warm before it is connected to the electrical supply the green OPERATIONAL light may illuminate immediately.

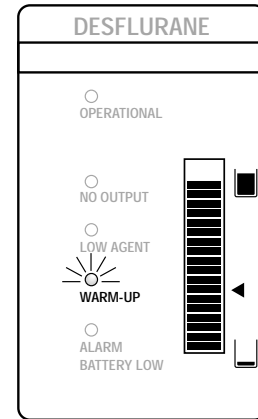

AA-43.039

**Fig. 13 Amber WARM-UP Light**

7. After a warm-up period of up to 10 minutes check that the amber WARM-UP light extinguishes and the green OPERATIONAL light illuminates to indicate that the vaporizer is ready for use.
8. If the OPERATIONAL light does not illuminate within 10 minutes, refer to Section 8.0 Fault Diagnosis.

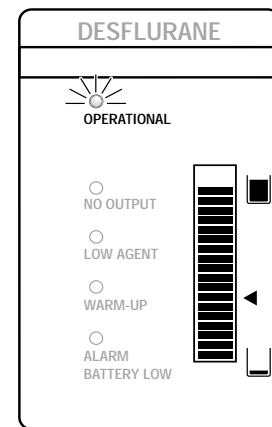





AA-43.040

**Fig. 14 Green OPERATIONAL Light**

## 5.2 Preoperative Checkout

1. Perform the leak test as described in the relevant anesthesia system's Operation And Maintenance Manual initially with the dial at 0. Repeat the test with the vaporizer dial turned to the 1% setting and then turn the dial to the 0 setting.
2. Check the amber ALARM BATTERY LOW light. If the light is illuminated, fit a new battery as described in Section 6.2 and check that the light extinguishes.
3. Turn the dial to a setting of 1% or above and then isolate the vaporizer from the electrical supply by disconnecting the mains lead from its outlet socket.
4. Wait for at least 15 seconds and then check that both the auditory alarm and the red NO OUTPUT light are activated.
5. If the alarm and light are not activated, do not use the vaporizer until the fault is rectified.
6. When the alarm and light are activated, turn the dial to the 0 setting, reconnect the mains lead and check that the alarm and display test is activated.
7. When the green OPERATIONAL light illuminates, continue operation.

### 5.3 Turning The Dial To The Required Setting

-  **Warning:** High % dial settings combined with low gas flows may lead to hypoxic mixtures within the breathing circuit. Datex-Ohmeda strongly recommends the use of oxygen monitoring.
  -  **Warning:** The dial release must be operated to turn the dial from the 0 setting and also to increase the dial setting to above 12%. Do not operate the dial release when turning the dial to any other setting, it may result in overriding the 12% stop and causing an inadvertent delivery in excess of 12%.
  -  **Warning:** The vaporizer has not been calibrated at any dial setting between 0 and 1%. Do not use the vaporizer at dial settings between 0 and 1%.
  -  **Warning:** It is a requirement of the ASTM Standard F1850-98 and the European Standard EN 740 - Anaesthetic Workstations And Their Modules, that the gas monitoring device referred to in Section 2.1 of this manual is in operating condition, by being enabled and functioning, prior to use of the vaporizer.
1. Operate the dial release and turn the dial in a counter-clockwise direction from the 0 setting, as illustrated in Fig. 15.
  2. Release the dial release and turn the dial to the required percentage setting.

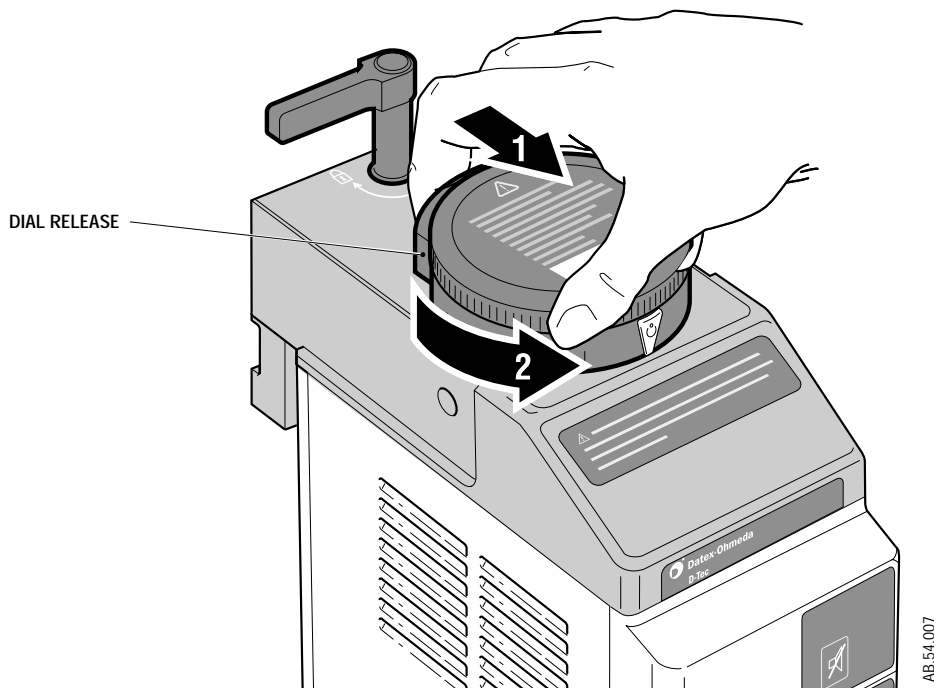

**Fig. 15 Turning The Vaporizer Dial**

3. Check that when the vaporizer dial is turned from the 0 setting, the dial of no other vaporizer mounted on the same manifold can be turned.
4. Turn the dial to the 0 setting and check that the dial release springs out.

*Note: The vaporizer will remain in standby 0, ready for further use if required, until the electrical supply is disconnected.*

## 5.4 Filling The Vaporizer

### 5.4.1 General



**Warning:** Do not fill the vaporizer with any substance other than Suprane™ (desflurane). If any substance other than Suprane™ (desflurane) is used, patient injury could occur.



**Warning:** When the vaporizer is in use, do not fill the vaporizer if the following conditions apply:

- The dial setting is more than 8% at flows of 8 liters/minute or above.
- The vaporizer is subjected to any high back pressure.
- The Suprane™ (desflurane) has been refrigerated or chilled below 18°C.

Failure to comply with this warning may result in a temporary decrease in delivered concentration and activate the NO OUTPUT alarm.



**Warning:** The vaporizer must be filled when it is in an upright position. Failure to do so may result in the vaporizer being over filled.



**Warning:** The vaporizer must only be filled when it is connected to the electrical supply. This enables the agent level on the agent level display to be observed. Do not attempt to fill the vaporizer when the level display indicates that it is full.

The D-Tec Vaporizer must only be filled when it is in an upright position. The vaporizer sump can be filled when the vaporizer is in its WARM-UP cycle, or at any time the vaporizer is in use. If the vaporizer is in its OPERATIONAL condition, the time taken for the agent to flow into the vaporizer may be increased. Only agent bottles with a "Saf-T-Fill"™ bottle probe specific to Suprane™ (desflurane) should be inserted into the filler port.

### 5.4.2 Filling Procedure

1. Remove the bottle cap from the Suprane™ (desflurane) bottle and ensure that the 'O' ring is correctly fitted to the bottle probe.
2. Insert the bottle probe into the filler port as illustrated in Fig. 16 and then push the bottle firmly against the spring pressure until it is fully engaged with the filler port.

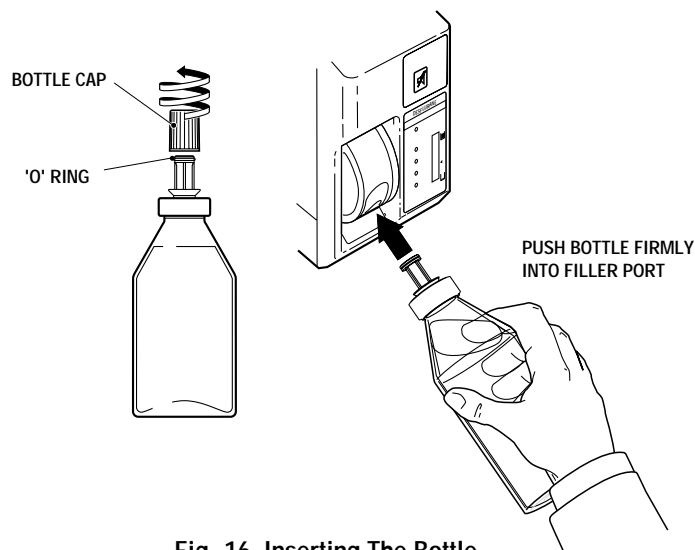

Fig. 16 Inserting The Bottle

AA-43.050



**Warning:** Ensure that the bottle probe is fully engaged into the filler port before attempting to lift the bottle. If the bottle cannot easily be lifted, do not force it otherwise the valve may be broken.

3. When the probe cannot be inserted any further into the filler port, attempt to lift the bottle upwards.
4. If the bottle cannot easily be lifted it may be because the bottle has not been completely inserted, therefore firmly push the bottle straight into the filling port to its full extent to make sure that it is fully inserted.
5. When the bottle moves easily, lift it upwards to lock the bottle onto the filler port as illustrated in Fig. 17.
6. When the bottle reaches the upper stop, bubbling of agent in the bottle will occur for a period of up to 45 seconds before the agent flows from the bottle through the filler port into the vaporizer sump.
7. Hold the bottle in position at the upper stop and fill until the bottle is empty or the indicator on the front display panel indicates that the sump is full.

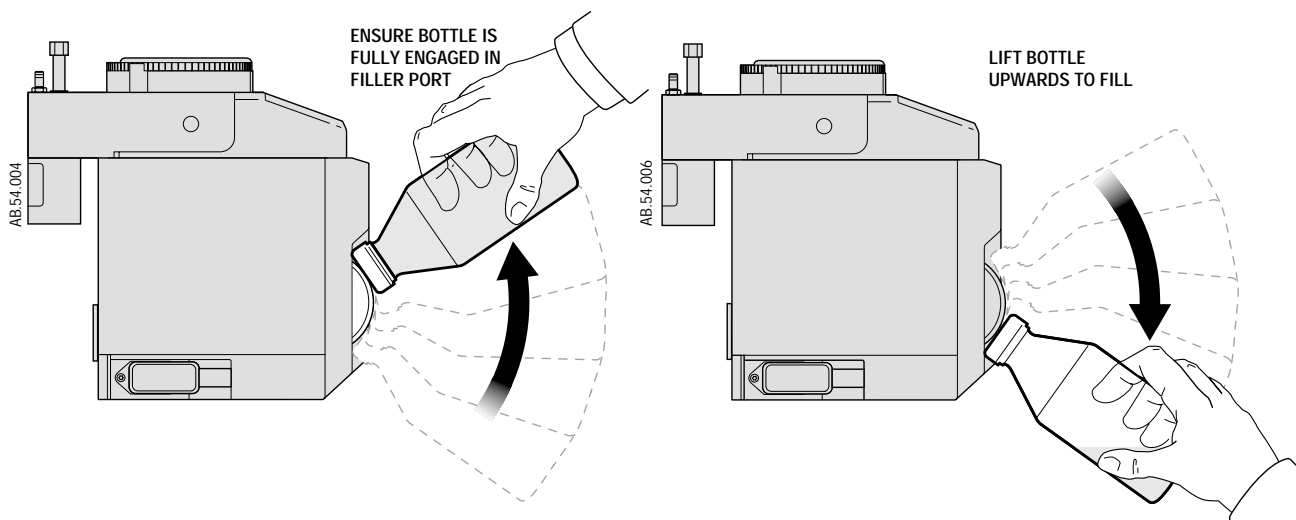

Fig. 17 Filling The Vaporizer



**Warning:** Grip the bottle firmly while rotating it downwards from the upper stop position to the lower stop position and hold the bottle firmly in the filler port until the small amount of agent in the filler system has drained back into the bottle. Failure to do so may result in spilling agent.

8. Grip the bottle firmly and lower it from the upper stop position to the lower stop position.
9. When the bottle reaches the lower stop position, hold the bottle firmly in the filler port for a minimum of 5 seconds to allow the small amount of agent in the filler system to drain back into the bottle.
10. To avoid dropping the bottle, support the bottle as it is automatically unlocked from the filler port and released from the filler.
11. The valve on the bottle automatically closes to help avoid loss of agent.

## 6.0 Maintenance

All D-Tec Vaporizers require a full service at the recommended service interval. The vaporizer must be serviced at a Datex-Ohmeda Authorized Service Center. Refer to Section 11.0 Servicing Policy.

### 6.1 Cleaning



**Warning: Do not put any substance other than Suprane™ (desflurane) into the vaporizer sump.**



**Warning: Do not immerse the vaporizer in water or any other liquid.**



**Warning: Do not autoclave the vaporizer.**



**Warning: Do not allow cleaning agents to accumulate in the filler, the gas inlet and outlet ports or around the control dial.**

For disinfection purposes, cleaning agents of a surface germicide type should be used. In terms of material compatibility, cleaning agents which contain the following active ingredients are suitable for use:

- Aldehydes,
- Alcohol,
- Quaternary ammonium compounds.



**Warning: To avoid possible damage to the vaporizer, do not use the following compounds as cleaning agents:**

- Halogen hydrolysing compounds,
- Strong organic acids,
- Oxygen hydrolysing compounds.

#### 6.1.1 External Cleaning

To clean external surfaces, use a moist cloth and a neutral detergent (pH 7 to 10.5).

#### 6.1.2 Internal Contamination

If the vaporizer is filled or partly filled with an incorrect volatile agent or other contaminant, proceed as follows:

Return the vaporizer to an Authorized Service Center stating that the vaporizer is contaminated and if possible, the type of contaminant in the vaporizer.

## 6.2 Changing The Battery

The battery must be changed every 12 months irrespective of condition.

1. Turn the dial to  $\odot$  and disconnect the mains lead from the electrical supply.
2. Unscrew the battery cover securing screw and remove the battery cover from the base of the vaporizer.
3. Remove the battery from the vaporizer and disconnect the terminals. Dispose of the battery.



**Caution:** Only a Duracell 1604 or VARTA Energy 2000, 9 Volt battery must be installed in the vaporizer. If any other battery is installed, it may damage the vaporizer.



**Warning:** The battery terminals must be firmly clipped onto the battery to help prevent a possible disconnection when the vaporizer is moved.

4. Clip the terminals firmly onto a new battery observing the correct polarity and insert the battery into the vaporizer. Fit the battery cover to the base of the vaporizer and tighten the securing screw.

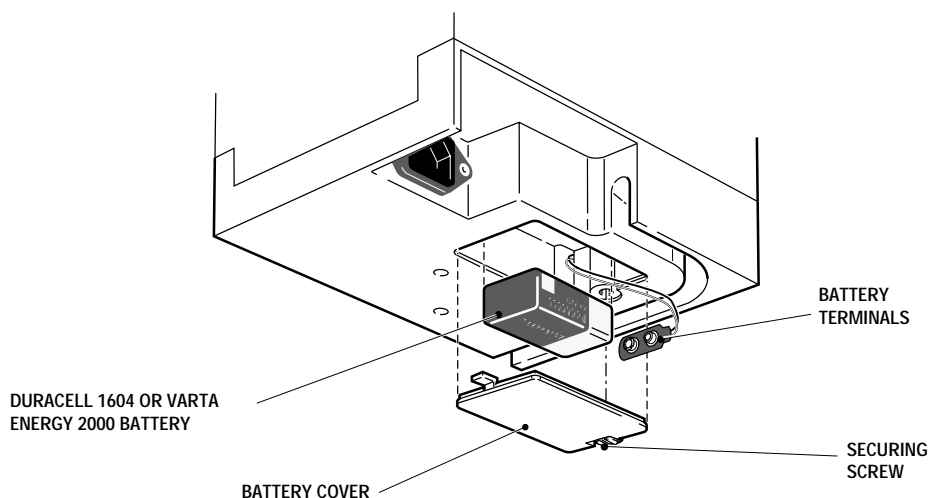

Fig. 18 Changing The Battery



**Warning:** Do not throw batteries onto a fire, do not open with force and do not recharge. To do so may result in operator injury. When disposing of batteries, they must be treated as special waste and disposed of according to local regulations.

## 6.3 Spare Parts

Description	Part No.
Mains Lead, North America - Long*	1107-3189-000
Mains Lead, North America - Short	1107-3190-000
Battery	1373256

\* All units ship with a long cord

## 7.0 Principle Of Operation (Fig. 19)

### 7.1 Alarm And Indicator Display

1. When the electrical supply is connected, each light and each LCD agent level display bar on the front display panel (17) flashes and the auditory alarm activates to indicate that the alarms are operational. After approximately two seconds, each light is extinguished, the LCD bars stop flashing and the auditory alarm is silenced.
2. The amber WARM-UP light is illuminated to indicate that the vaporizer is in its warm-up cycle and the LCD agent level display bars indicate the amount of agent in the sump.
3. During the warm-up cycle, the shut-off valve (8) is closed to prevent the supply of vapor to the pressure regulating valve (7), and the electronics (16) perform the zero check.
4. When the vaporizer attains the required operating temperature, the amber WARM-UP light is extinguished and the green OPERATIONAL light illuminates to indicate that the vaporizer is ready for use.

### 7.2 Delivery Of Gas/Agent Vapor

1. When the vaporizer is ready for use, a signal from the electronics (16) operates the solenoid (19) in the interlock mechanism which allows the dial and rotary valve (1) to be turned.
2. When the dial and rotary valve (1) are turned, a signal from the electronics (16) opens the shut-off valve (8).
3. The pressure control transducer (3) sends a signal of the difference between the gas inlet pressure and the regulated agent pressure to the electronics (16). The electronics alters the regulated agent pressure by opening or closing the pressure regulating valve (7) to balance the pressures.
4. When the regulated agent pressure of the circuit is equal to the gas inlet pressure, the vaporizer functions correctly.
5. The dial and rotary valve (1) indicated in Fig. 19, regulate the volume of vapor being delivered to the fresh gas mixture.
6. The fresh gas mixes with the vapor just prior to the gas/agent outlet in the proportions consistent with the selected dial setting.

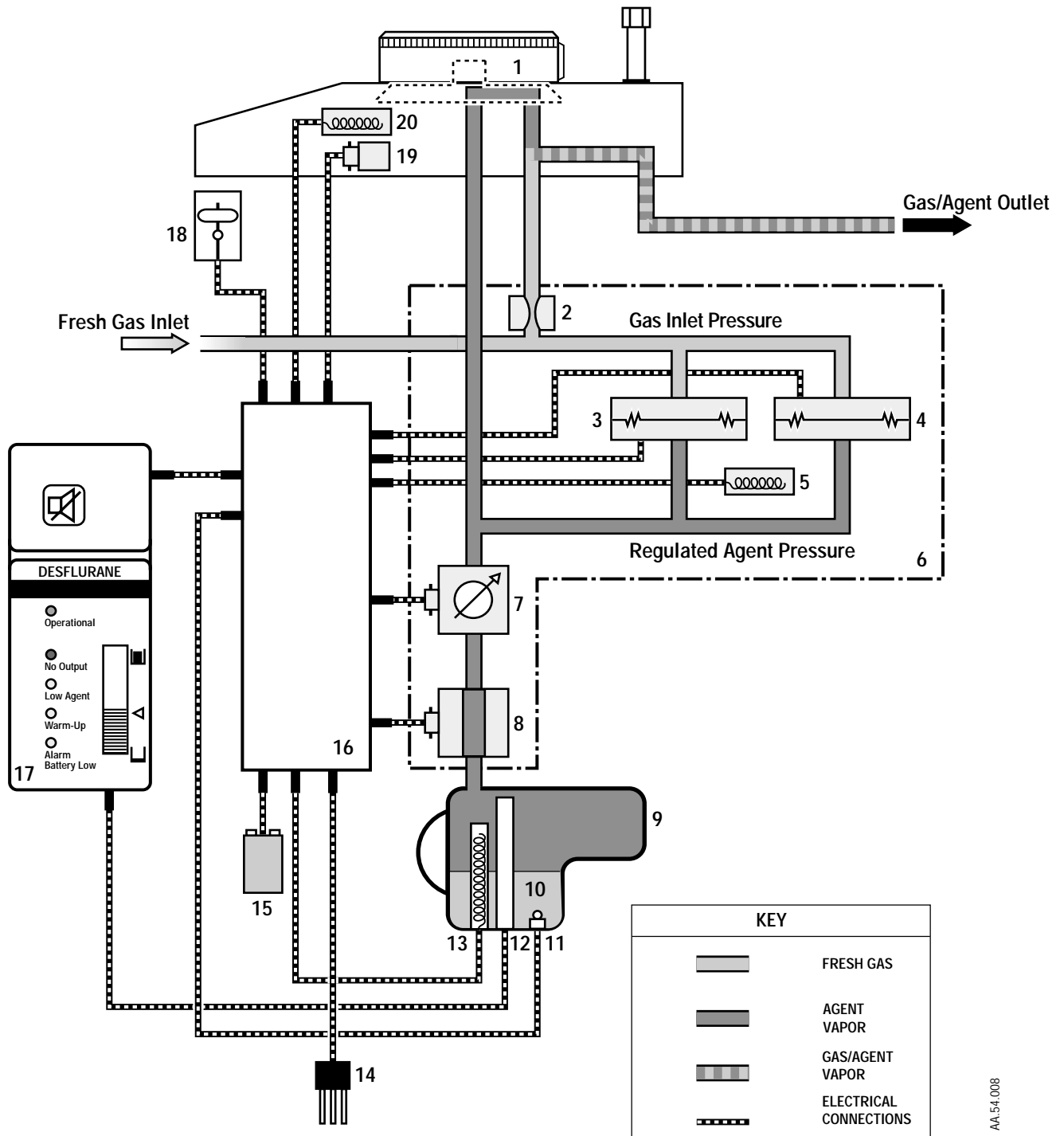

AA.54.008

KEY TO COMPONENTS			
1	DIAL & ROTARY VALVE	11	LEVEL SWITCH
2	FIXED RESTRICTOR	12	LEVEL SENSOR
3	PRESSURE CONTROL TRANSDUCER	13	SUMP HEATERS
4	PRESSURE MONITOR TRANSDUCER	14	MAINS LEAD
5	HEATER IN VAPOR CONTROL MANIFOLD	15	BATTERY
6	VAPOR CONTROL MANIFOLD ASSEMBLY	16	ELECTRONICS
7	PRESSURE REGULATING VALVE	17	FRONT DISPLAY PANEL
8	SHUT-OFF VALVE	18	TILT SWITCH
9	SUMP ASSEMBLY	19	SOLENOID IN THE INTERLOCK BLOCK
10	AGENT	20	HEATER IN THE VALVE PLATE

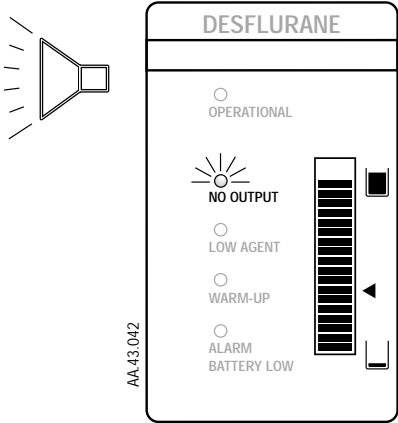
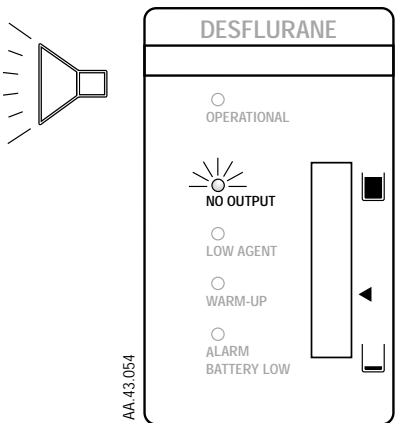

Fig. 19 Vaporizer Schematic



## 8.0 Fault Diagnosis

The following table details the alarm condition and the actions which must be performed to correct the alarm condition and the possible fault.

If the vaporizer fails to function correctly after the appropriate action has been taken to rectify the fault, send the vaporizer to a Datex-Ohmeda Authorized Service Center for repair.

Vaporizer Status	Action	Possible Cause
<p>The vaporizer dial release can be depressed, but the dial will not turn. When more pressure on the dial release is applied, a click on the mechanism is detected. The dial still cannot be turned.</p>	<p>Let go of the dial release, then:</p> <ol style="list-style-type: none"> <li>Allow the vaporizer to warm up until the green OPERATIONAL light illuminates.</li> <li>If another vaporizer is in use, turn the other vaporizer to OFF/⊙.</li> </ol>	<ol style="list-style-type: none"> <li>During WARM UP, the interlock mechanism prevents vaporizer use.</li> <li>The interlock mechanism of another vaporizer is operative.</li> </ol>
Alarm Indication	Action	Possible Fault
	<p>Turn the dial to ⊙. The vaporizer may red alarm for 10 seconds before going to operational, or go through system check before going operational, depending on time of external power restoration, or permanently red alarm if internal power failure.</p> <p><b>Warning:</b> Use an alternative means of anesthesia.</p>	<p>Power failure.</p> <p>Tilt.</p> <p>Any internal malfunction.</p>
	<p>Turn the dial to ⊙. If the dial is at ⊙ press the . If the LOW AGENT alarm is activated after 10 seconds, fill the sump with Suprane™.</p> <p><b>Warning:</b> If the NO OUTPUT alarm persists, use an alternative means of anesthesia.</p>	<p>Agent level &lt; 20 ml.</p>

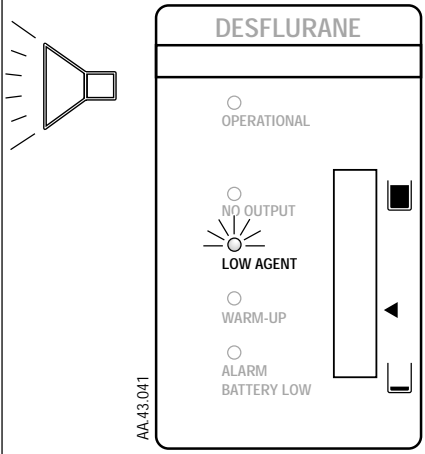
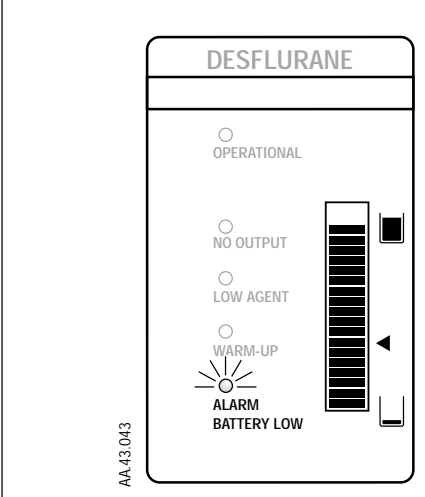
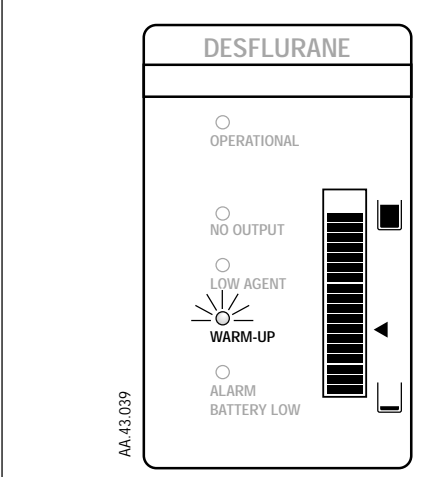
Alarm Indication	Action	Possible Fault
 <p>AA-43.041</p>	<p>Fill the sump with Suprane™.</p>	<p>Agent level &lt; 60 ml.</p> <p><b>Warning:</b> If this condition persists until there is less than 20 ml of agent in the sump, the NO OUTPUT alarm is activated and the output ceases.</p>
 <p>AA-43.043</p>	<p>Change the battery within eight hours of alarm indication</p>	<p>Alarm battery low.</p>
 <p>AA-43.039</p>	<p><b>Warning:</b> Do not attempt to use the vaporizer.</p>	<p>If the amber WARM-UP light does not extinguish within ten minutes after the vaporizer is connected to an electrical supply, there may be an internal malfunction.</p>

## 9.0 Specification

*Note: All specifications are nominal and subject to change without notice.*

### 9.1 Calibration



**Warning: The D-Tec Vaporizer can only be calibrated at a Datex-Ohmeda Authorized Service Center.**

The D-Tec Vaporizer is calibrated at 760 mm Hg and at a nominal 21°C for the following concentrations (v/v %): 1, 2, 3, 4, 5, 6, 7, 8, 9, 10, 12, 14, 16 and 18, using O<sub>2</sub> as the carrier gas flowing at 5 liters/minute.

### 9.2 Electrical Supplies

Voltage Requirement:	100 to 120V a.c. 50/60 Hz
Power Consumption:	250 VA nominal
Current Input:	Supply - 120 Volts, Maximum Current Requirement is 2.0 Amps

The ~ symbol on the rating label denotes that the external mains electrical supply must be single phase sinusoidal alternating current.

### 9.3 Performance

Concentration Range:	1 to 18%
Scale:	1% graduations from 1 to 10% 2% graduations from 10 to 18%
Calibrated Flow Range at 21 ± 2°C:	0.2 to 10 liters/minute
Accuracy at 5 liters/minute O <sub>2</sub> :	± 0.5% of delivered agent or ± 15% Dial Setting (whichever is the greater)
Liquid Capacity:	390 ml nominal volume (indicated on level display) 240 ml refill capacity indicator nominal 60 ml reserve (not indicated on level display)
Flow Resistance:	Less than 50 cm H <sub>2</sub> O at 5 liters/minute of O <sub>2</sub> at 21°C Less than 250 cm H <sub>2</sub> O at 15 liters/minute of O <sub>2</sub> at 21°C
Battery:	Duracell 1604 or VARTA Energy 2000
Ambient Operating Temperature Range:	18°C to 30°C. (64° F to 86°F.)
Storage Temperature Range:	-40°C to 60°C. (-40°F to 140°F.)
Storage Relative Humidity Range:	30% to 75%
Storage Atmospheric Pressure:	700 to 1060 hPa

## 9.4 Classification

Continuous rating, the vaporizer can be powered indefinitely unless a fault condition occurs.

Type of protection against electric shock is Class 1. Accessible conductive parts of Class 1 equipment are connected to a protective earth in such a way that they do not become live in the event of a failure of the basic insulation.

The rating label denotes the degree of protection against electric shock which is Type B.

The vaporizer is not protected against ingress of liquids.

## 9.5 Weight And Dimensions

Weight:	10 kg	22 lb (empty)
Depth:	235 mm	9 1/4 inches
Width:	110 mm	4 3/8 inches
Height:	235 mm	9 1/4 inches

## 9.6 Flow Characteristics

The graph shows the nominal output of the D-Tec Vaporizer at 760 mm Hg.

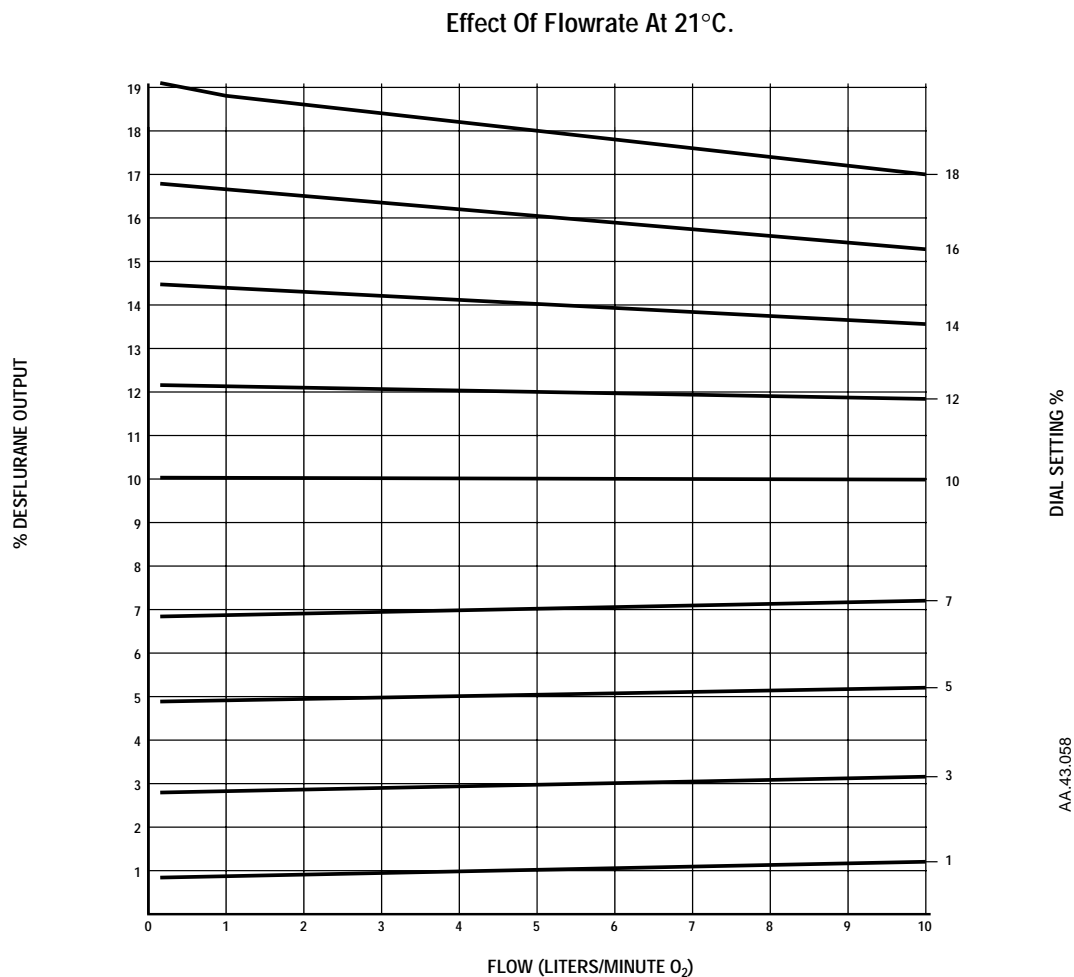

## 9.7 Effects Of Output At Varied Altitudes

The D-Tec Vaporizer has been calibrated in % v/v and the calibration is not affected by ambient pressure changes. The partial pressure of the delivered agent at any selected dial setting varies directly with the changes in ambient air pressure. The required dial setting may be calculated using the following formula:

$$\text{Required Dial Setting} = \text{Normal Dial Setting \% v/v} \times \frac{760 \text{ mm Hg}}{\text{ambient pressure (mm Hg)}}$$

The table below shows the dial setting on a D-Tec Vaporizer at altitudes of 1000 m and 2000 m respectively above sea level:

Normal Dial Setting % v/v	Required Dial Setting %	
	At an altitude of 1000 m (3282 feet)	At an altitude of 2000 m (6564 feet)
5	5.5	6
10	11	12.5
14	17	18

## 9.8 Effects Of Ambient Temperature

The performance of the D-Tec Vaporizer is not significantly affected by the temperature variations within the operating range specified in Section 9.3.

## 9.9 Effects Of Back Pressure

Fluctuating Back Pressure does not significantly affect the output of the D-Tec.

Steady Back Pressure does not significantly affect the concentration of the agent delivered (v/v), but does increase partial pressure of the agent. The increase is in the ratio of total back pressure to the vaporizer calibration pressure of 760 mm Hg.

## 9.10 Effects Of Carrier Gas Composition

Small output decreases can occur when the carrier gas composition is changed from 100% oxygen.

When either air or nitrous oxide is employed as the carrier gas, the output is lowered compared to the output when oxygen is the carrier gas. This effect is the greatest (up to 20% of setting) at low flows when nitrous oxide is employed, but using nitrous oxide reduces the required inspired concentrations of volatile agent which can, depending upon the proportion, mitigate the decreases in output from the vaporizer.

## 10.0 Warranty

This product is sold by Datex-Ohmeda under the warranties set forth in the following paragraphs.

Such warranties are extended only with respect to the purchase of this Product directly from Datex-Ohmeda or Datex-Ohmeda's Authorized Dealers as new merchandise.

Datex-Ohmeda warrants that at the time of delivery the D-Tec Vaporizer is warranted against any defects in workmanship and materials and will conform to the description of the Product contained in the Operation and Maintenance manual and accompanying labels and inserts, provided that it is operated under conditions of normal use, that regular periodic maintenance and service is performed and that replacements and repairs are made in accordance with the instructions provided.

Datex-Ohmeda's sole obligation under this warranty is limited to repairing or replacing, free of charge, at Datex-Ohmeda's option, a Product which is shown to Datex-Ohmeda's reasonable satisfaction to have been defective; following notification to Datex-Ohmeda and, where requested, return of the Product to Datex-Ohmeda in accordance with the instructions contained in the Servicing Policy section of the O & M Manual, within twenty-four (24) months of the date of original delivery.

Without limitation, D-Tec Vaporizers which:

- (i) have been altered or repaired other than the express written authorization of Datex-Ohmeda or in accordance with its approved procedures; or
- (ii) have been subjected to misuse, improper maintenance, negligence, or accident; or
- (iii) have been damaged by excessive or 'dirty'/'noisy' electrical current or had the serial number or any part thereof altered, defaced, or removed,

shall not be considered defective.

**Datex-Ohmeda shall not be otherwise liable for any damages including but not limited to incidental damages, consequential damages, or special damages.**

**There are no express or implied warranties which extend beyond the warranties herein set forth. Datex-Ohmeda makes no warranty of merchantability of fitness for a particular purpose with respect to the Product or parts thereof.**

## 11.0 Servicing Policy



**Warning: Only Technicians/Engineers trained and certificated by Datex-Ohmeda to repair and/or service the Datex-Ohmeda D-Tec Vaporizer should attempt to repair and/or service it and it must be repaired and/or serviced in accordance with written instructions provided by Datex-Ohmeda.**

Repairs and service procedures must be performed at a Datex-Ohmeda Authorized Service Center. A Datex-Ohmeda Service Representative can be contacted at the nearest Datex-Ohmeda Service Center or Datex-Ohmeda Authorized Distributor.

The service includes the following:

1. Disassembly of certain components.
2. Cleaning.
3. Inspection for damage and wear.
4. Replacement of damaged and/or worn components.
5. Updating the D-Tec Vaporizer as appropriate.
6. Calibration check of the D-Tec Vaporizer.
7. Alarm and safety checks.

If the equipment is to be transported to the nearest Datex-Ohmeda Service Center, package the vaporizer and mains cable securely for protection in its original packaging, and ship it prepaid.

Enclose the following items as applicable:

1. A letter describing in detail any difficulties experienced with the equipment.
2. Warranty information such as a copy of the invoice or other documentation.
3. Purchase order number to cover repair or service of equipment not under warranty.
4. Ship to and bill to information.
5. The name and telephone number of the person to contact.

This vaporizer requires servicing every two years.

# Index

## A

- Accuracy 22
- Agent Level Display 7
- Agent Level Sensor
  - Description 5
- Alarm And Display Test 11
- Alarm Battery Low 8, 21
- Altitudes
  - Effects Of Output 24
- Ambient Temperature
  - Effects Of 24
- Auditory And Visual Indicators
  - Description 6

## B

- Back Pressure
  - Effects Of 24
- Battery 17, 22
  - Changing 17
  - Disposal 17
  - Fitting 9
- Bottle
  - Suprane™ (desflurane) 14

## C

- Calibration 22
- Carrier Gas Composition
  - Effects Of 24
- Classification 23
  - Class 1 23
  - Type B 23
- Cleaning 16
- Component Information
  - Drain Plug 4
  - Filler Assembly 4
  - Power Supply Connector And Battery 4
  - Power Supply Unit 4
  - Tilt Switch 5
- Contamination 16
- Controls And Indicators
  - Auditory And Visual Indicators 6
- Current Input 22

## D

- Description
  - General 3
- Dial
  - Description 6
  - Operation 13
- Dial Release
  - Operation 13
- Drain Plug
  - Description 4

## E

- Electrical Supplies
  - Current Input 22
  - Power Consumption 22
  - Voltage Requirement 22
- Equi-Potential Stud
  - Description 5

## F

- Fault Diagnosis 20
  - Action 20, 21
  - Alarm Indication 20, 21
  - Possible Fault 20, 21
- Federal law 1
- Filler Assembly
  - Description 4
- Filling Procedure 14
- Flow Characteristics 23

## H

- Heater Elements
  - Description 5

## I

- Introduction 1

## L

- Leak Test
  - Negative Pressure 12
  - Positive Pressure 12
- Liquid Capacity 22
- Low Agent 8, 20

## M

- Maintenance 16
  - Changing The Battery 17
  - Cleaning
    - External Cleaning 16
    - Internal Contamination 16
  - Spare Parts 17
- Monitoring
  - Oxygen 13
- Monitors
  - Description 5
- Mute Button 6, 11



# Index

## N

No Output 8, 20

## O

### O & M Manual

Of Anaesthesia Machine 12

### Operating Instructions 11

Filling The Vaporizer 14

Preoperative Checkout 12

Turning The Dial 13

### Operational 7

## P

Performance 22

Power Consumption 22

### Power Supply Connector And Battery

Description 4

### Power Supply Unit

Description 4

### Precautions

Warnings And Cautions 1

### Preoperative Checkout 12

### Principle Of Operation 18

Alarm And Indicator Display 18

Delivery Of Gas/Agent Vapor 18

## R

### Range

Calibrated Flow 22

Concentration 22

### Recommendations

IEC 601 3

UL 544 3

## S

Schematic 19

### Service

Center 20

### Servicing

Policy 26

Repairs 26

Warranty information 26

### Spare Parts 17

### Specification 22

Calibration 22

Effects Of Ambient Temperature 24

Effects Of Back Pressure 24

Effects Of Carrier Gas Composition 24

Effects Of Output At Varied Altitudes 24

Performance 22

Weight And Dimensions 23

### Status Display

Agent Level Display 7

Alarm Battery Low 8

Low Agent Level 8

No Output 8

Operational 7

Warm Up 7

### Sump

Description 5

### Symbols 2

## T

### Temperature 22

Operating 22

Storage 22

### Tilt Switch

Description 5

## V

### Vaporizer Mounting Procedure

Mounting The Vaporizer 9

### Voltage Requirement 22

## W

Warm Up 7, 12, 21

# Datex-Ohmeda

## Corporate Office



Datex-Ohmeda Division  
Instrumentarium Corp.  
PO Box 900  
FIN-00031 Helsinki  
Finland  
Tel 358 10 394 11  
Fax 358 9 146 3310

## North America

### United States

#### **Customer Service, Technical Support and Distribution Center**

Datex-Ohmeda, Inc.  
PO Box 7550  
Madison, WI 53707-7550, USA  
Tel 1 800 345 2700  
Fax 1 608 221 4384

### Equipment Service Center

Datex-Ohmeda, Inc.  
1315 West Century Drive  
Louisville, CO 80027-9560, USA  
Tel 1 800 345 2700  
Fax 1 303 673 1607

### Canada

Datex-Ohmeda (Canada) Inc.  
1093 Meyerside Drive, Unit 2  
Mississauga, Ontario  
L5T 1J6  
Canada  
Tel 800 268 1472  
Tel 905 565 8572  
Fax 905 565 8592

## Asia/Pacific

### China

Datex-Ohmeda Pte. Ltd.  
Room B416, COFCO Plaza  
8 Jianguomennei Avenue  
Beijing 100005, PR China  
Tel 86 10 6526 9773  
Fax 86 10 6526 0653

Datex-Ohmeda Pte. Ltd.  
Room 1708, Yunlong Mansion  
No. 122 Luoguo Street  
Chengdu 610017, PR China  
Tel 86 28 661 4424  
Fax 86 28 676 2703

Datex-Ohmeda Pte. Ltd.  
403 Huan Shi Dong Road  
Room 1602, GIE Tower  
Guangzhou, 510095, P R China  
Tel 86 20 8732 2521  
Fax 86 20 8732 2518

Datex-Ohmeda Pte. Ltd.  
Room 2509 Lippo Plaza  
No. 222 Huaihai Road (M)  
Shanghai 200021, P.R. China  
Tel 8621 5382 5657  
Fax 8621 5382 1691

Datex-Ohmeda Pte. Ltd.  
Room 809, Truroli Plaza  
Wusheng Road  
Wuhan 430033, P R China  
Tel 86 27 8571 2536  
Fax 86 27 8571 2655

### India

Datex-Ohmeda (India) Pvt. Ltd.  
Block EP & GP, Sector V  
Plot XI-16, Salt Lake City  
Calcutta 700091  
India  
Tel 91 33 3574002  
Fax 91 33 3574001

### Indonesia

Datex-Ohmeda Pte. Ltd.  
Wisma Danamon Aetna Life 19th Floor  
Jln. Jend Sudirman Kav. 45-46  
Jakarta 12930, Indonesia  
Tel 62 21 575 0864  
Fax 62 21 575 0865

### Japan

Datex-Ohmeda K. K.  
TRC Annex 9F  
6-1-1 Heiwajima  
Ohta-ku, Tokyo 143-0006  
Japan  
Tel 81 3 5763 6801  
Fax 81 3 5763 6838

Datex-Ohmeda K. K.  
Technical Center  
TRC A Bldg. AE 4-8  
6-1-1 Heiwajima  
Ohta-ku, Tokyo 143-0006  
Japan  
Tel 81 3 5763 6850  
Fax 81 3 5763 6852

### Korea

Datex-Ohmeda Pte. Ltd.  
10th Floor, Sam Sung Building  
36 - 1, Yoido-Dong, Youngdeungpo-Ku  
Seoul, Korea  
Tel 82 2 786 7421  
Fax 82 2 786 7420

### Malaysia

Datex-Ohmeda Pte. Ltd.  
Level 2 Bangunan O'Connor  
13 Jalan 223  
46100 Petaling Jaya  
Selangor, West Malaysia  
Tel 60 3 754 7872  
Fax 60 3 757 6948

### Singapore

Datex-Ohmeda Pte. Ltd.  
152 Beach Road  
#12-05/07 Gateway East  
Singapore 189721  
Tel 65 391 8618  
Fax 65 291 6618

### Thailand

Datex-Ohmeda Pte. Ltd.  
12th Floor (Unit F) Grand Amarin Tower  
1550 New Petchburi Road, Makasan,  
Rajathevi,  
Bangkok 10320, Thailand  
Tel 66 2 2071012/13  
Fax 66 2 207 1014

### Taiwan and Philippines

Datex-Ohmeda Pte. Ltd.  
2nd Floor, No. 85, Chien-Kuo North  
Road, Sec. 2  
Taipei, Taiwan  
Republic of China  
Tel 886-2 2515-0457  
Fax 886-2 2501-9136

### Vietnam

Datex-Ohmeda Pte. Ltd.  
522G Nguyen Tri Phuong St.  
Ho Chi Minh City, Dist. 10 Vietnam  
Tel 848 865 5875  
Fax 848 862 5501

## Australia

Datex-Ohmeda Pty. Ltd.  
Units 1 & 2  
149 Arthur Street  
P O Box 356  
Homebush  
NSW 2140  
Australia  
Tel 61 132 229  
Fax 61 297 461796

## Europe

### France

Datex-Ohmeda S.A.S.  
17 rue Jean-Elysée Dupuy  
69410 Champagne Au Mont d'Or  
France  
Tel 33 (0) 4 78 66 62 10  
Fax 33 (0) 4 78 43 26 58

### Germany

Datex-Ohmeda GmbH  
Dr-Alfred-Herrhausen-Allee 24  
D-47228 Duisburg  
Germany  
Tel 49 2065 691-0  
Fax 49 2065 691-236

### Italy

Datex-Ohmeda S.p.A.  
Via Cassanese 100  
20090 Segrate, Milan  
Italy  
Tel 39 2 21693431  
Fax 39 2 26926226

### Netherlands

Datex-Ohmeda B.V.  
Kantemarsweg 18  
Post Box 22  
3870 CA Hoevelaken  
Netherlands  
Tel 31 33 253 5404  
Fax 31 33 253 7223

### Spain

Datex-Ohmeda S.L.  
C/Manuel Tovar 26  
28034 Madrid  
Spain  
Tel 34 1 334 26 00  
Fax 34 1 358 12 84

### United Kingdom

Datex-Ohmeda Ltd.  
Ohmeda House  
71 Great North Road  
Hatfield Hertfordshire  
AL9 5EN England  
Tel 44 1707 263570  
Fax 44 1707 260191

## Latin America, Caribbean

Datex-Ohmeda  
9155 South Dadeland Blvd.  
Suite 1218  
Miami, FL 33156, USA  
Tel 1 305 670 8540  
Fax 1 305 670 2316

## Middle East

Datex-Ohmeda  
Middle East Operations  
P O Box 5527  
Dubai, United Arab Emirates  
Tel 97 14 822653  
Fax 97 14 822659

Datex-Ohmeda, Inc.  
PO Box 7550  
Madison WI 53707-7550  
USA  
Tel 1 608 221 1551  
Fax 1 608 222 9147  
www.datex-ohmeda.com

1107 0622 000  
08 01 D 1 21 03  
Printed in USA

©Datex-Ohmeda, Inc. All rights reserved