

HUNTLEIGH

Anwendungshinweise

Kullanım Talimatları

Brugsvejledning

Instrucciones de uso

; χρήσης

使用方

Mode d'emploi

Gebruiksaanwijzing

Bruksanvisning

aanwijzing

INSTRUCTIONS FOR USE

Bruksar

alimatları

使用方法

Käyttöohjeet

Instruções de Utilização

Istruzioni per l'uso

Anwendungshinweise

Οδηγίες χρήσης

Anwendungshinweise

Hydroven 12

Contents

1. Safety	3
1.1 Warnings.....	3
2. Electromagnetic Compatibility	5
3. Introduction.....	8
3.1 About this Manual.....	8
3.2 Intended Use	8
3.3 About the Hydroven 12 system	8
3.4 Use Environment	9
4. Clinical Applications	10
4.1 Indications.....	10
4.2 Contraindications	11
5. Preliminary Checks	12
6. Garment and Insert Information.....	13
6.1 Garment Dimensions.....	14
7. Hydroven 12 System.....	16
7.1 Garment Connections	16
7.2 Operating Modes.....	17
7.2.1 Standby.....	17
7.2.2 Sleep Mode.....	17
7.2.3 Run Mode	17
7.3 Inflation Modes.....	18
7.3.1 Sequential Inflation	18
7.3.2 Wave Inflation	18
7.3.3 LymphAssist Inflation.....	19
7.3.4 Linking LymphAssist with other Therapy cycles	20
8. Controls, Indicators and Alarms.....	21
8.1 Typical Control Panel in Run mode	21
8.2 Pump Controls and Indicators.....	21
8.2.1 Run/Standby Button, and Run and Sleep Mode Indicators	22
8.2.2 Inflation Mode Select Button and Indicators	22
8.2.3 Pressure Display and Pressure Setting Buttons.....	23
8.2.4 Therapy Setting Select Button and Therapy Setting Indicators	23
8.2.5 Therapy Setting Display and Therapy Setting Buttons	24
8.2.6 Storing New Therapy Settings	25
8.3 Pump Alarm.....	25
8.3.1 System Fault.....	25

9. Operation	26
9.1 Preparing the System	26
9.2 Checking the Therapy Settings	28
9.3 Changing the Therapy Settings	29
9.3.1 Setting the Pressure	29
9.3.2 Setting the Inflate/Deflate Times	29
9.3.3 Setting the Treatment Duration	30
9.4 Starting Therapy	30
9.5 Stopping Therapy	31
9.6 Storing New Therapy Settings	31
9.7 Control Panel Lockout	31
9.7.1 Pressure Setting	31
9.7.2 Inflation Mode and Therapy Time Settings	32
10. Decontamination	33
10.1 Cleaning	33
10.2 Chemical Disinfection	33
10.3 Cleaning and Sterilising Garments	33
11. Routine Maintenance	34
11.1 Hydroven 12 System	34
11.1.1 Maintenance	34
11.1.2 Servicing	34
11.1.3 Service Period	34
11.2 General Care, Maintenance and Inspection	34
11.2.1 Pump	34
11.2.2 Garments	34
11.3 Serial Number Labels	34
11.3.1 Pump	34
11.3.2 Garments	34
12. Trouble Shooting	35
13. Accessories	36
14. Specifications	37
14.1 Equipment Classification	37
14.2 General	37
14.3 Environmental	38
14.4 Standards Compliance	38
15. Product Labelling	39
16. End of Life Disposal	40
17. Warranty & Service	41
17.1 Service Returns	41

1. Safety



Before using this equipment, please study this manual carefully and familiarise yourself with the controls, display features and operation. Ensure that each user fully understands the safety and operation of the unit, as misuse may cause harm to the user or patient, or damage to the product.

Please keep these Instructions for Use to hand for future reference.

Symbols



General Warning / Cautions



Follow Instructions for Use

1.1 Warnings

Do NOT use unapproved accessories or attempt to modify, disassemble or otherwise misuse the Hydroven 12 system. Failure to observe this caution could result in injury, or in extreme cases, death.



WARNING: A possible explosion hazard exists if used in the presence of flammable anaesthetics.



WARNING: Do not mount the unit directly above the patient. Locate the unit so that it will not cause harm should it fall.



WARNING: Do not operate the unit from the mains supply if the mains cable is damaged.



WARNING: Do not immerse any portion of the unit in water or other liquids.



WARNING: Use only recommended accessories listed in this manual.



WARNING: If this product is connected to another item of electrical equipment, it is important that the system is fully compliant with EN60601-1.



WARNING: It is the responsibility of the care giver to ensure that the user can use this product safely.



WARNING: Make sure that the mains power cable and tubeset or air hoses are positioned to avoid causing a trip or other hazard, and are clear of moving bed mechanisms or other possible entrapment areas.



WARNING: Electrical equipment may be hazardous if misused. There are no user-serviceable parts inside the pump. The pump's case must only be removed by authorised technical personnel. No modification of this equipment is allowed.



WARNING: The mains power socket/plug must be accessible at all times. To disconnect the pump completely from the electricity supply, remove the plug from the mains power socket.



WARNING: Disconnect the pump from the mains power socket before cleaning and inspecting.



WARNING: Only the pump and garment/insert combination as indicated by Huntleigh should be used. The correct function of the product cannot be guaranteed if incorrect pump and garment combinations are used.



WARNING: Bags supplied with this equipment may present a suffocation risk; to avoid the risk of suffocation, keep the bags away from babies and small children.



CAUTION: Do not expose the system to naked flames, such as cigarettes, etc.



CAUTION: Do not store the system in direct sunlight.



CAUTION: Do not use phenol-based solutions to clean the system.



CAUTION: Make sure the system is clean and dry prior to use or storage.



CAUTION: Pets and children must be supervised in the vicinity of the system.

Expected Service Life

The Hydroven 12 has an expected service life of 7 years. To maintain the condition of the pump have it serviced regularly according to the schedule recommended by your Huntleigh distributor.

2. Electromagnetic Compatibility

Make sure the environment in which Hydroven 12 is installed is not subject to strong sources of electromagnetic interference (e.g. radio transmitters, mobile phones).

This equipment generates and uses radio frequency energy. If not installed and used properly, in strict accordance with the manufacturer's instructions, it may cause or be subject to interference. Type-tested in a fully configured system, complies with EN60601-1-2, the standard intended to provide reasonable protection against such interference. Whether the equipment causes interference may be determined by turning the equipment off and on. If it does cause or is affected by interference, one or more of the following measures may correct the interference:

- Reorienting the equipment
- Relocating the equipment with respect to the source of interference
- Moving the equipment away from the device with which it is interfering
- Plugging the equipment into a different outlet so that the devices are on different branch circuits



WARNING: The Hydroven 12 should not be used adjacent to or stacked with other equipment and that if adjacent or stacked use is necessary, the Hydroven 12 should be observed to verify normal operation in the configuration in which it will be used

Guidance and Manufacturer's declaration - electromagnetic emissions		
The Hydroven 12 is intended for use in the electromagnetic environment specified below. The customer or the user of the Hydroven 12 should assure that it is used in such an environment.		
Emissions Test	Compliance	Electromagnetic Environment - guidance
RF emissions CISPR 11	Group 1	The Hydroven 12 uses RF energy only for its internal function. Therefore, its RF emissions are very low and are not likely to cause any interference in nearby electronic equipment.
RF emissions CISPR 11	Class B	
Harmonic emissions IEC 61000-3-2	Class A	
Voltage fluctuations / flicker emissions IEC 61000-3-3	Complies	

Guidance and Manufacturer's declaration - electromagnetic immunity			
The Hydroven 12 is intended for use in the electromagnetic environment specified below. The customer or the user of the Hydroven 12 should assure that it is used in such an environment.			
Immunity Test	IEC 60601 test level	Compliance level	Electromagnetic Environment - guidance
			Portable and mobile RF communications equipment should be used no closer to any part of the Hydroven 12, including cables, than the recommended separation distance calculated from the equation applicable to the frequency of the transmitter.
Conducted RF IEC 61000-4-6	3 Vrms 150kHz to 80MHz	3V	$d = 1.2 \sqrt{P}$
Radiated RF IEC 61000-4-3	3 Vrms 80MHz to 2.5MHz	3V/m	$d = 1.2 \sqrt{P}$ 80MHz to 800MHz $d = 2.3 \sqrt{P}$ 800MHz to 2.5GHz
			<p>where P is the maximum output power rating of the transmitter in watts (W) according to the transmitter manufacturer and d is the recommended separation distance in metres (m).</p> <p>Field strengths from fixed RF transmitters, as determined by an electromagnetic site survey, ^a should be less than the compliance level in each frequency range ^b. Interference may occur in the vicinity of the equipment marked with the following symbol:</p> 
<p>NOTE 1 At 80MHz and 800MHz, the higher frequency range applies.</p> <p>NOTE 2 These guidelines may not apply in all situations. Electromagnetic propagation is affected by absorption and reflection from structures, objects and people.</p>			
<p>^a Field strengths from fixed transmitters, such as base stations for radio (cellular/cordless) telephones and land mobile radios, amateur radio, AM and FM radio broadcast and TV broadcast cannot be predicted theoretically with accuracy. To assess the electromagnetic environment due to fixed RF transmitters, an electromagnetic site survey should be considered. If the measured field strength in the location in which the Hydroven 12 is used exceeds the applicable RF compliance level above, the Hydroven 12 should be observed to verify normal operation. If abnormal performance is observed, additional measures may be necessary, such as re-orienting or relocating the Hydroven 12.</p> <p>^b Over the frequency range 150kHz to 80kHz, field strengths should be less than 3V/m.</p>			

Recommended separation distances between portable and mobile RF communications equipment and the Hydroven 12			
The Hydroven 12 is intended for use in an electromagnetic environment in which radiated RF disturbances are controlled. The customer or user of the Hydroven 12 can help prevent electromagnetic interference by maintaining a minimum distance between portable and mobile RF communications equipment (transmitters) and the Hydroven 12 as recommended below, according to the maximum output power of the communications equipment.			
Rated maximum output power of transmitter W	Separation distance according to frequency of transmitter m		
	150kHz to 80MHz $d = 1.2 \sqrt{P}$	80MHz to 800MHz $d = 1.2 \sqrt{P}$	800MHz to 2.5GHz $d = 2.3 \sqrt{P}$
0.01	0.12	0.12	0.23
0.1	0.38	0.38	0.73
1	1.2	1.2	2.3
10	3.8	3.8	7.3
100	12	12	23

For transmitters rated at a maximum output power not listed above, the recommended separation distance d in metres (m) can be estimated using the equation applicable to the frequency of the transmitter, where P is the maximum output power rating of the transmitter in watts (W) according to the transmitter manufacturer.

NOTE 1 At 80MHz and 800MHz, the separation distance for the higher frequency range applies.

NOTE 2 These guidelines may not apply in all situations. Electromagnetic propagation is affected by absorption and reflection from structures, objects and people.

3. Introduction

3.1 About this Manual

This manual is your introduction to the Hydroven® 12 system.

You must read and fully understand this manual before using the system. Use this manual to initially set up the system, and keep it as a reference for day-to-day routines and as a guide to maintenance.

If you have any difficulties in setting-up or using the Hydroven 12 system, contact your local Huntleigh sales representative, listed at the end of this manual.

3.2 Intended Use

The intended use of this product is to manage the list of clinical conditions detailed in the “Indications” section.

The Hydroven 12 system should be used as part of a prescribed plan of care detailed in the “Indications” section.

3.3 About the Hydroven 12 system

The system comprises a pump and multi-chamber arm or leg garments. Optional multi-chamber garment inserts can be used to increase the circumference of the arm and leg garments.

The pump supplies air to inflate the chambers in the garments via connecting tubes, allowing the application of controlled pressure to gently compress and/or massage the limb.

The pump has three inflation modes:

- **Sequential.**
- **Wave.**
- **LymphAssist®.**

Sequential and **Wave** inflation are used for the treatment of wounds, chronic venous insufficiency, and venous or dependency oedema. The gentle compression of the limb increases the return of blood and excess fluids, improves venous stasis and encourages the reabsorption of waste products.

LymphAssist inflation is used where there is a requirement to move lymph away from malfunctioning lymphatics. The gentle, rhythmic massage of the limb throughout the LymphAssist cycle moves the skin in the direction of the lymph flow and stimulates the lymphatic vessels, which carry proteins and waste products.

The pump can also be set to “link” LymphAssist cycles with Sequential or Wave cycles to treat patients with lympho-venous oedema.

A full technical description of the Hydroven 12 system can be found in the Service Manual, part number SER0010, available from your local Huntleigh sales representative.

3.4 Use Environment

Hydroven 12 is suitable for use in hospital, primary care and community settings. It must not be used outdoors, or in any environment where it may come into contact with water.

4. Clinical Applications

4.1 Indications

Intermittent Pneumatic Compression (IPC) is effective in the treatment of the following clinical conditions, when combined with an individualised monitoring programme:

- Oedema.
 - Dependent (including secondary to cerebrovascular incident, pregnancy or paralysis).
 - Traumatic (post-surgical or injury).
- Lymphoedema.
 - Primary and secondary (including post surgery, radio or chemotherapy).
- Chronic venous insufficiency.
- Post phlebotic syndrome.
- Acute and chronic wounds including venous leg ulcers and post-surgical wounds.

IPC may also be beneficial in the management of:

- Fixed flexion deformity.
- Arthritic conditions.
- Lower limb pain due to trauma or surgery.
- Lipoedema.

Selection should be based upon a holistic assessment of the patients' individual care needs.

Note: *These systems represent one aspect of a treatment strategy; if the patient's condition changes the overall therapy regimen should be reviewed by the prescribing clinician.*

Note: *The above are guidelines only and should not replace clinical judgement.*

4.2 Contraindications

IPC should NOT be used in the following circumstances:

- Known or suspected deep vein thrombosis (DVT), pulmonary embolism, thrombophlebitis and acute infections of the skin, such as cellulitis.
- Decompensated/severe congestive cardiac failure, pulmonary oedema associated with significant limb oedema or any condition where an increase of fluid to the heart may be detrimental.
- Severe arteriosclerosis or other ischaemic vascular disease.
- Active metastatic disease affecting the limb.

NOTE TO PATIENT: if you are uncertain whether you have any of the above conditions please consult a physician before use.



CAUTION: IPC should be used with care in patients with the following symptoms or conditions:

- ***Peripheral neuropathy, pain or numbness in the limb.***
- ***Undiagnosed, untreated or infected wounds, fragile skin, grafts or dermatological conditions that may be aggravated by the garment.***
- ***Extreme limb deformity which may practically impede the correct application of the garment.***



WARNING: Therapy should be interrupted if pain, tingling or numbness of the limb occurs during or as a result of therapy.



WARNING: In the event of a power failure or fault whereby the garment remains inflated, disconnect the tubeset(s) in order to deflate the garment(s) and then remove the garment(s) from the limb(s).



WARNING: Patients must not walk or stand when wearing leg garments.

5. Preliminary Checks

Contents (supplied with each system)

Item	Item
1 x Hydroven 12	1 x Instructions for Use

Delivery Inspection

Huntleigh Healthcare Ltd takes every precaution to ensure that goods reach you in perfect condition. However, accidental damage can occur in transit and storage. For this reason we recommend that a thorough visual inspection is made immediately the unit is received. Should any damage be evident or any parts missing, ensure that Huntleigh Healthcare Ltd is informed at once.

Storage

If the unit not be required for immediate use, it should be re-sealed into its original packing after carrying out the initial delivery inspection, and stored under covered conditions at a temperature between -20°C to +50°C, and relative humidity of 20% to 95% non-condensing.

After exposure to extreme temperatures during storage, the pump must be allowed to adjust to normal operating temperatures for a minimum of 12 hours before use. Failure to do this may result in accelerated wear of mechanical components.

6. Garment and Insert Information



WARNING: *Bags supplied with this equipment can present a suffocation risk; to avoid the risk of suffocation, keep the bags away from babies and small children.*

The Hydroven 12 pump is designed to be used with Hydroven™ 12 garments, which are available in two sizes for arms and four sizes for legs. Each length arm and leg garment has a corresponding Hydroven 12 insert piece which increases its circumference by 17 cm for arm garments and 19 cm for leg garments.

The length of the tubeset is 140 cm from the pump connector to the foot/hand end of the garment.

All garments (arm garments, leg garments and garment inserts) have multiple chambers. Each chamber overlaps the adjacent chamber to provide smooth and seamless pressure application, and prevent pressure voids or ridging to the limbs. All garments have zip closures. When closed, the inflating chamber section overlaps underneath the zip around the whole circumference of the limb to prevent pressure voids and ridging of the skin underneath the zip section. The leg garment (and leg garment insert) has a unique 5-chamber foot section which provides fine application of pressure to the foot, promoting blood and lymph movement.

Garment inserts are available for arm and leg garments to fit larger limbs. Once connected to the garment and pump they are designed to inflate in sequence with the garment to provide unique inflation capabilities for larger limbs.

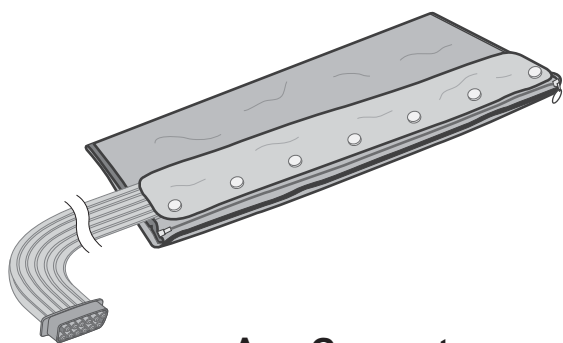

Arm Garment

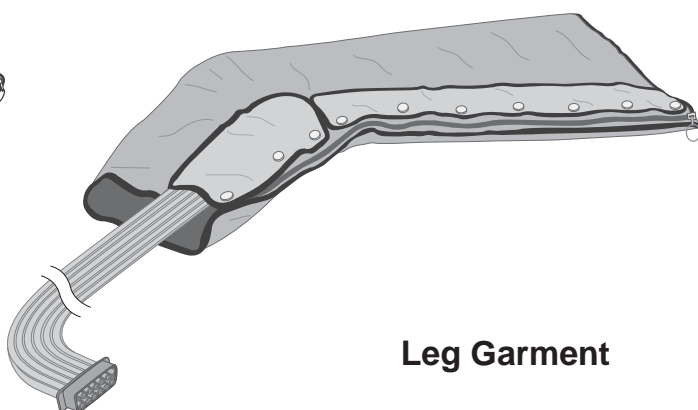

Leg Garment

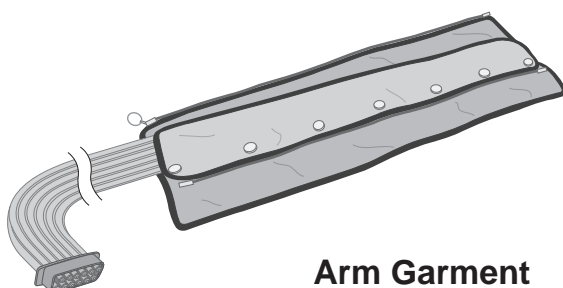

**Arm Garment
Insert Piece**

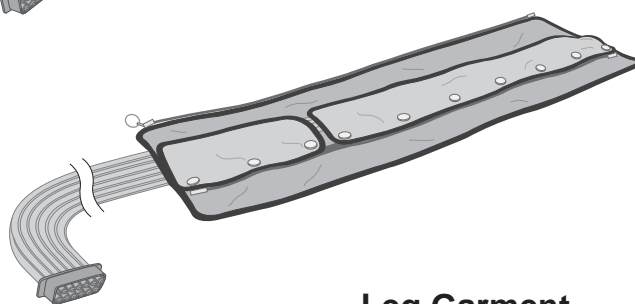

**Leg Garment
Insert Piece**

6.1 Garment Dimensions

Limbs should be measured and the correct garment(s) chosen using the following measuring guides and tables of dimensions.

When determining the correct garment size:

- Remove any bandages, stockings and/or any bulky dressings.
- Measure the circumference of the limb where stated.
- When measuring, do not pull the tape measure tight.
- Make sure the garment extends above the level of the swelling/trauma, whilst maintaining the level of comfort.

Note: *Garments should not feel tight-fitting when deflated.*

1. Arm Garments:

- The length of the garment is measured from the fingertips to 5 cm below the armpit, with the arm straight.
- The circumference of the garment is measured at the shoulder

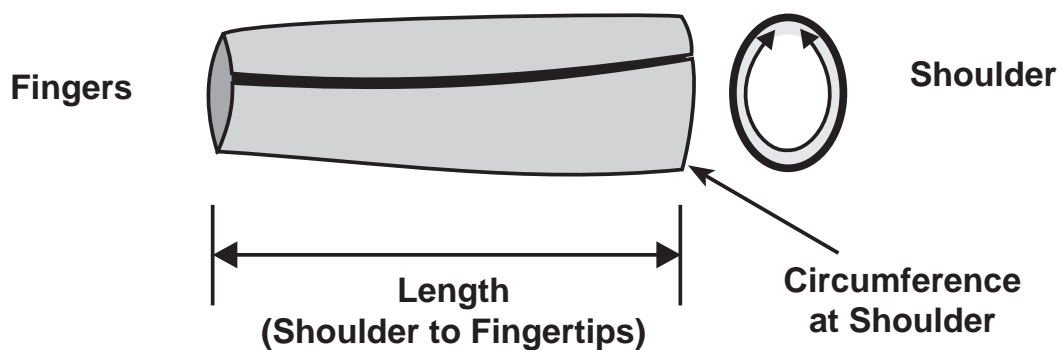

Arm Garment Dimensions		
Garment Part No.	316A68	316A78
Length (shoulder to fingertips)	68 cm	78 cm
Circumference (at shoulder)		
Arm Garment	62 cm	62 cm
with Garment Insert	79 cm	79 cm
Corresponding Insert Piece Part No.	316AI68	316AI78
Width of Insert (at shoulder)	17 cm	17 cm

Note: *The Hydroven 12 arm garment insert piece adds 17 cm to the shoulder-end circumference of the garment.*

2. Leg Garments:

- There are two ranges of leg garments: standard and large.
- The length of the garment is measured from the heel to 5 cm below the groin.
- The circumference of the garment is measured at the top of the thigh.

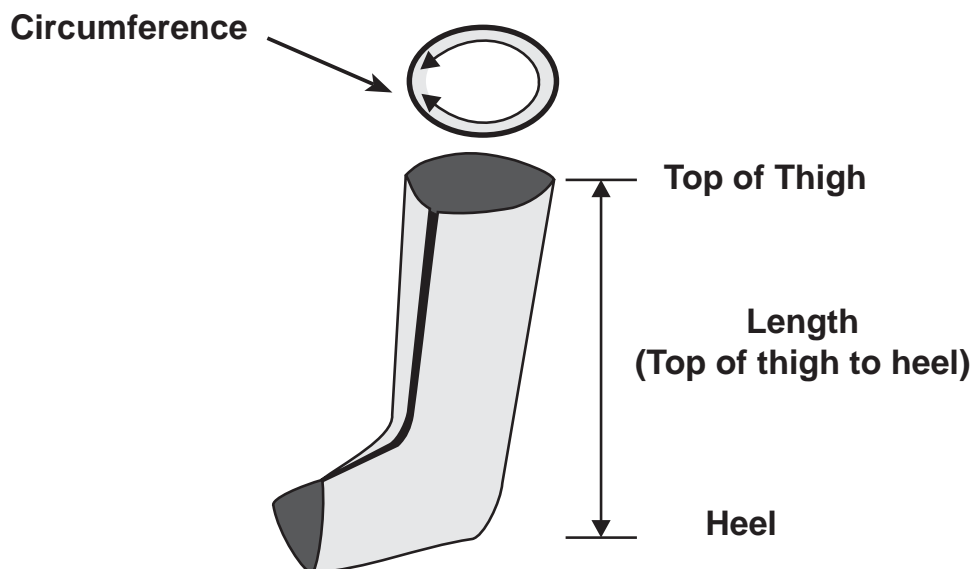

Leg Garment Dimensions	Standard		Large	
Garment Part No.	316L76S	316L84S	316L76W	316L84W
Length (top-of-thigh to heel)	76 cm	84 cm	76 cm	84 cm
Circumference (at top-of-thigh)				
Leg Garment	71 cm	71 cm	79 cm	79 cm
with Garment Insert	90 cm	90 cm	98 cm	98 cm
Corresponding Insert Piece Part No.	316LI76	316LI84	316LI76	316LI84
Width of Insert (at top of thigh)	19 cm	19 cm	19 cm	19 cm

Note: *The Hydroven 12 leg garment insert piece adds 19 cm to the top-of-thigh circumference of the garment.*

For further information about garment sizing, please contact Huntleigh.

7. Hydroven 12 System

The Hydroven 12 pump is designed for table-top use, with the controls situated at the front of the pump. It comprises a moulded case with non-slip feet on the base and rear cover, and an integral carry handle.

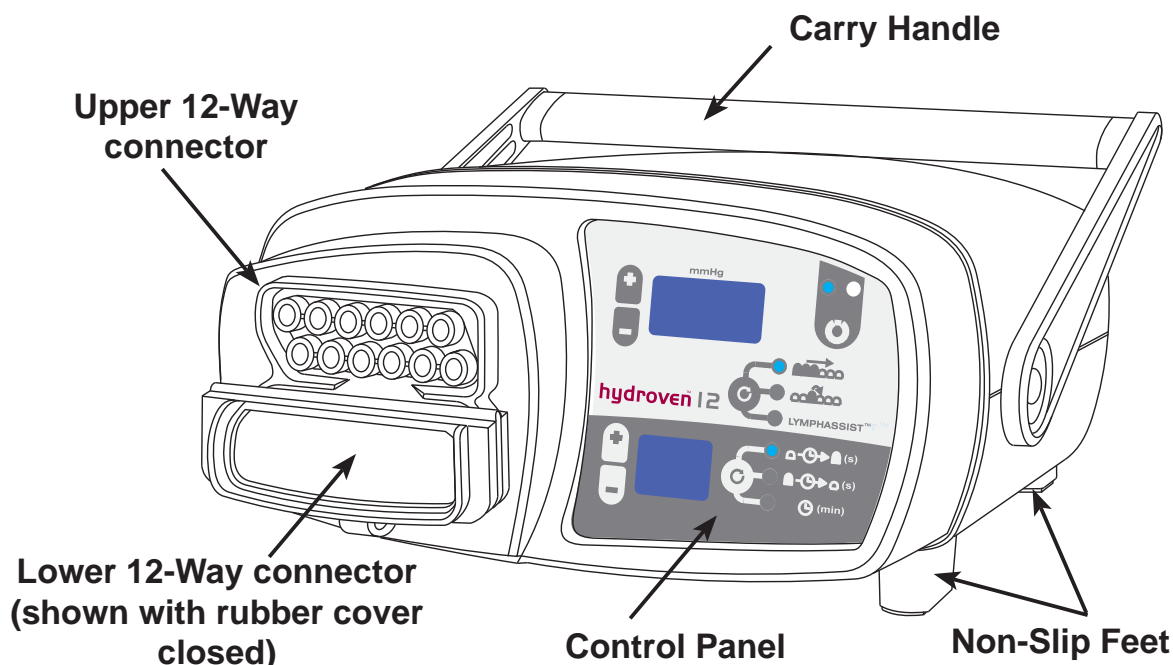

7.1 Garment Connections

There are two 12-way connectors on the front of the pump. They are covered by a 2-part, hinged, rubber cover, which is secured to the pump by a strap. The cover is fitted over both connectors when the pump is being cleaned to prevent ingress of fluids.

The garments are connected to these two 12-way connectors, which are push-fit and polarised to prevent incorrect orientation of the connectors. The following pump/garment connections are possible:

- If two garments are used (either two arm garments, two leg garments, or one arm/leg garment and one garment insert), one will be connected to the upper connector and the other connected to the lower connector. The two connections are interchangeable - both garments will inflate at the same time and to the same pressure.
- If only one garment is used, it must be connected to the upper connector and the rubber cover must be securely fitted to the lower connector (folded as shown).

All garments (arm garments, leg garments and garment inserts) have multiple chambers. The chambers are inflated in a pre-determined sequence, according to the inflation modes detailed below. (Refer to "Inflation Modes").

The inflation of the chambers follows a preset pressure gradient, but the deflation of the chambers is effectively instantaneous.

7.2 Operating Modes

Refer to “Pump Controls and Indicators” for a description of the controls and indicators on the pump.

The pump has the following three operating modes:

7.2.1 Standby

After the mains power supply has been switched on to the pump, the pump will perform a short self-test and then go into Standby.

In Standby mode:

- The Run and Sleep mode indicators are extinguished.
- The pump shows the previously selected therapy settings.
- The pump is ready to start therapy. Press the Run/Standby button to start therapy.

7.2.2 Sleep Mode

If the pump has been in Standby for 10 minutes without any of the buttons being pressed, it then goes into Sleep mode to conserve power.

Note: *The pump can be left in Sleep mode for long periods without disconnecting the mains power.*

In Sleep mode:

- Only the Sleep mode indicator on the control panel is illuminated.
- All other displays and indicators are extinguished.
- Press the Run/Standby button to put the pump into Standby.

7.2.3 Run Mode

The pump is in Run mode for the duration of the therapy session, while it is inflating and deflating the garments.

In Run mode:

- The Run mode indicator will be illuminated.
- The pump automatically stops at the end of the selected therapy time and the garments are deflated.
- The pump can be stopped during the therapy by pressing the Run/Standby button.

Note: *Loss of mains power will halt therapy.*

7.3 Inflation Modes

The pump has the following three inflation modes:

7.3.1 Sequential Inflation

1. The first garment chamber starts to inflate.
2. When the first chamber has been inflated to the correct pressure, the second chamber starts to inflate.
3. This sequence continues for all 12 chambers.

Note: *In Sequential mode, all chambers are kept fully inflated while subsequent chambers are inflated.*

4. After the final chamber has been inflated, all chambers are then deflated simultaneously.
5. The pressure in each chamber is less than the pressure in the preceding chamber, and the pressure in the final chamber is set to 60% of the pressure in the first chamber.

7.3.2 Wave Inflation

1. The first garment chamber starts to inflate.
2. When the first chamber has been inflated to the correct pressure, the second chamber starts to inflate.
3. When the second chamber has been inflated to the correct pressure, the first chamber starts to deflate and the third chamber starts to inflate.

Note: *The patient may feel that more than one chamber is inflated at any one time.*

4. This sequence continues for all 12 chambers.
5. The pressure in each chamber is less than the pressure in the preceding chamber, and the pressure in the final chamber is set to 60% of the pressure in the first chamber.

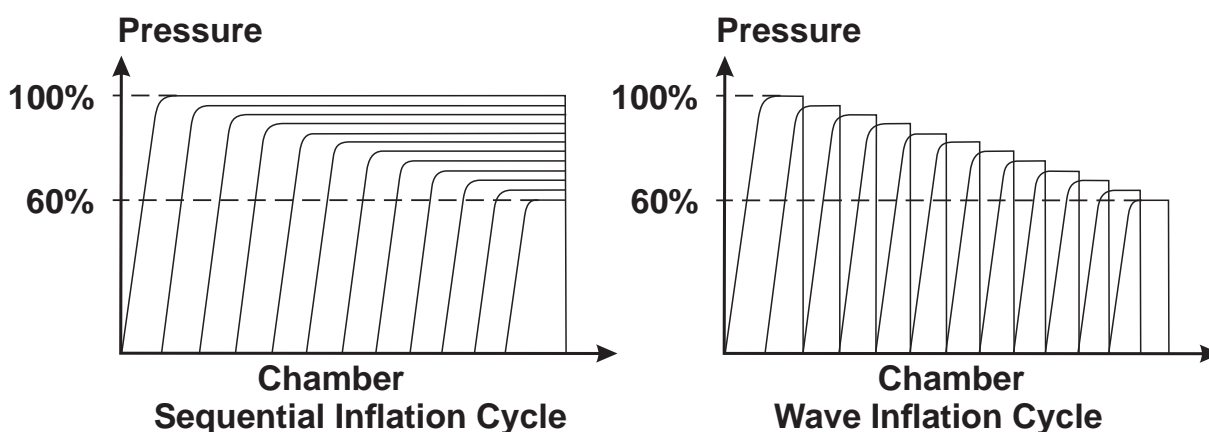

Note: *Wave inflation is also known as “peristaltic” inflation.*

7.3.3 LymphAssist Inflation

Refer to the diagram below for the LymphAssist cycle.

Note: *Chamber 1 is at the distal (foot/hand) end and chamber 12 is at the proximal (thigh/shoulder) end.*

1. On initial application, the LymphAssist therapy starts with a single peristaltic Wave inflation from chamber 1 to chamber 12.
2. A LymphAssist cycle is comprised of the following sequence of inflations/deflations, starting at chamber 12, then 11, 10, etc., down to chamber 1:
 - There are 5 pulses where the chamber is inflated and deflated. These are referred to as LymphAssist pulses.
 - This is followed by a single “partial”-peristaltic Wave inflation of part of the garment - between the next chamber and chamber 12.

For example, at chamber 5, the 5 LymphAssist pulses are followed by a partial-peristaltic Wave inflation from chamber 6 to chamber 12.

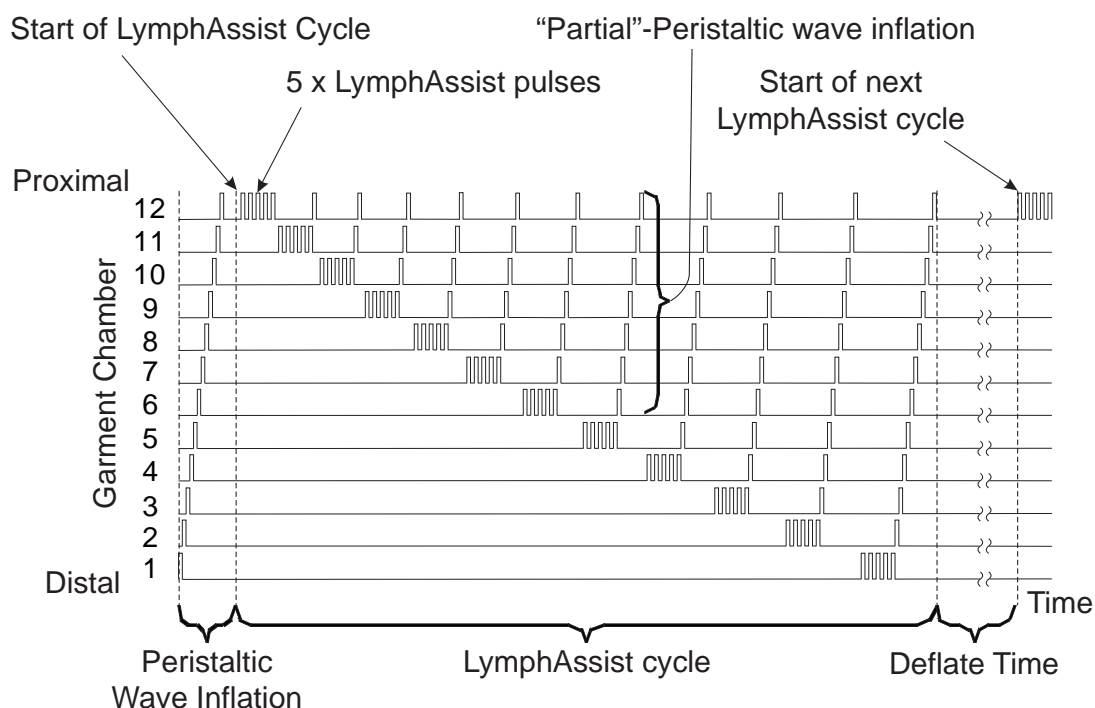

3. When the partial-peristaltic Wave inflation gets to chamber 12, there is a short delay, and then the sequence of 5 LymphAssist pulses followed by a partial-peristaltic Wave inflation is repeated for the next chamber.
4. The LymphAssist cycle is complete after the 5 LymphAssist pulses at chamber 1 and the partial-peristaltic Wave inflation from chamber 2 to chamber 12.
5. The next LymphAssist cycle will start after the Deflate time set on the pump control panel.

Note: *The maximum pump pressure that can be set in LymphAssist mode is 40 mmHg.*

7.3.4 *Linking LymphAssist with other Therapy cycles*

The LymphAssist cycle can be “linked” with Wave or Sequential cycles. In this mode of operation, a single LymphAssist cycle is followed by continuous Wave or Sequential cycles until the Treatment time has elapsed or the pump is turned off (Refer to “Inflation Modes”).

8. Controls, Indicators and Alarms

8.1 Typical Control Panel in Run mode

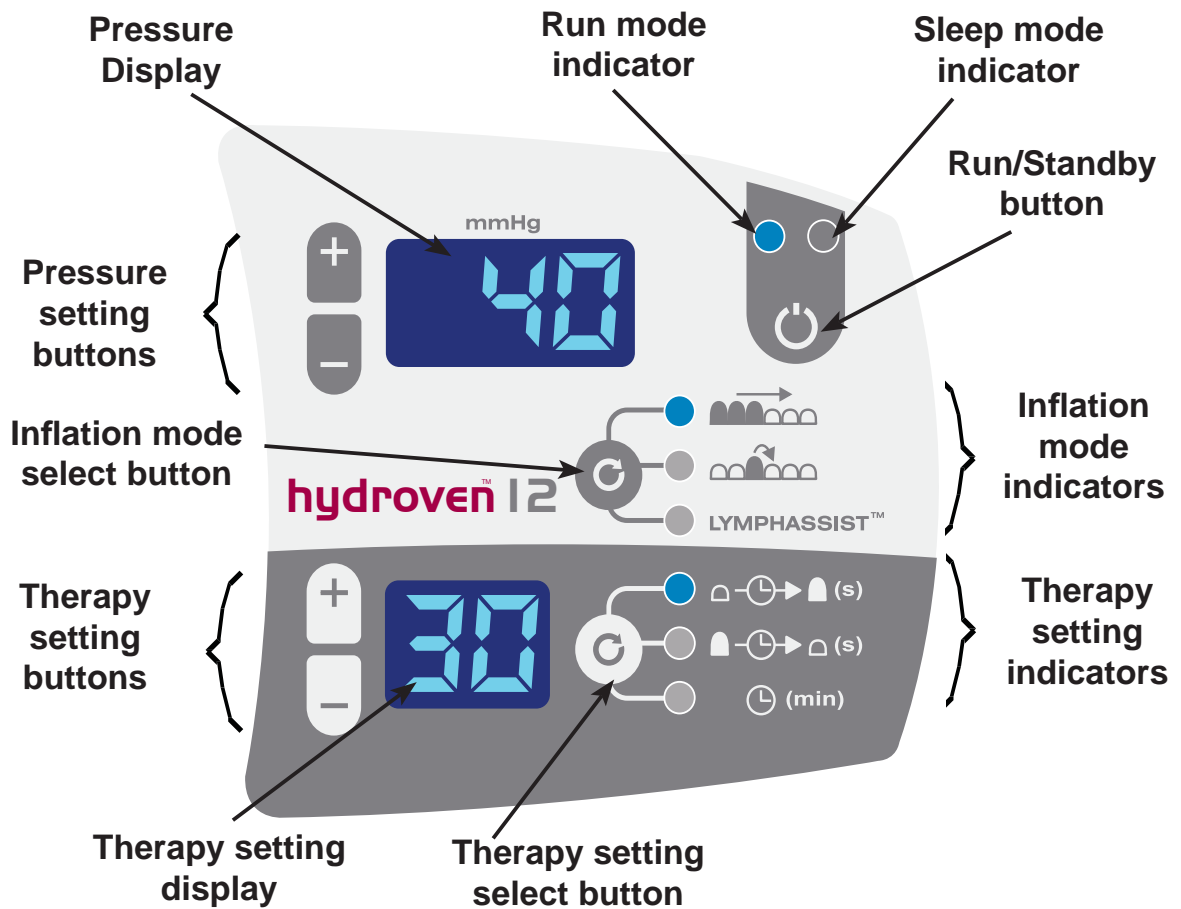

8.2 Pump Controls and Indicators

The pump control panel has the following controls and indicators:

Note: *When a button on the pump control panel is pressed, the sounder will “beep” to confirm a valid selection.*

8.2.1 Run/Standby Button, and Run and Sleep Mode Indicators

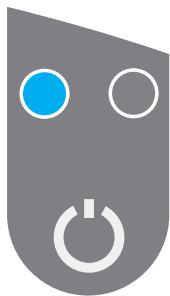

- When the pump is in Standby, both the Run and Sleep mode indicators are extinguished.
- Press the Run/Standby button to start the patient therapy. The Run mode indicator (the left one of the two indicators) is illuminated to show that the pump is in Run mode.
- At the end of the therapy, as set by the Treatment duration, the pump will stop. The pump can also be stopped during the therapy by pressing the Run/Standby button. Press the Run/Standby button after the pump has stopped to reset it to Standby.
- If the pump has been in Standby for 10 minutes with no button being pressed, it then goes into Sleep mode to conserve power.
- Only the Sleep mode indicator (the right one of the two indicators) is illuminated in Sleep mode, everything else is effectively shut down.
- Press the Run/Standby button to put the pump from Sleep mode into Standby.

Note: *The pump can be left in Sleep mode for long periods of time without disconnecting the mains power.*

8.2.2 Inflation Mode Select Button and Indicators

The pump has three main inflation modes: Sequential, Wave and LymphAssist. In addition, LymphAssist cycles can be linked with Sequential or Wave cycles, offering a total of five treatment alternatives. These modes are described in “Inflation Modes”.



Repeated presses of the Inflation Mode select button will cycle the pump through the five types of patient therapy, as follows:

- Sequential
- Wave
- LymphAssist
- LymphAssist plus Sequential (linked therapy cycles)
- LymphAssist plus Wave (linked therapy cycles)

For each of the three main inflation modes (Sequential, Wave and LymphAssist), the indicator adjacent to the selected Inflation Mode is illuminated.

With linked therapy cycles (LymphAssist plus Sequential and LymphAssist plus Wave):

- Initially, the two relevant Inflation Mode indicators are both illuminated.
- During the therapy, the Inflation Mode indicator will flash to show which cycle is currently operating. For example, if LymphAssist and Wave cycles are linked, then during the LymphAssist cycle the LymphAssist indicator will flash while the Wave indicator will be permanently illuminated. The indications will be reversed during the Wave cycle.

8.2.3 Pressure Display and Pressure Setting Buttons



The value shown on the Pressure display is the set pressure for the first garment chamber to be inflated.

The pressure range for each inflation mode is:

- Sequential: 15-120mmHg.
- Wave: 15-100mmHg.
- LymphAssist: 15-40mmHg.

The pressure can be adjusted in 5 mmHg increments by pressing the + and – Pressure setting buttons.

8.2.4 Therapy Setting Select Button and Therapy Setting Indicators

Repeated presses of the **Therapy Setting** select button selects which parameter is shown on the Therapy Setting display:

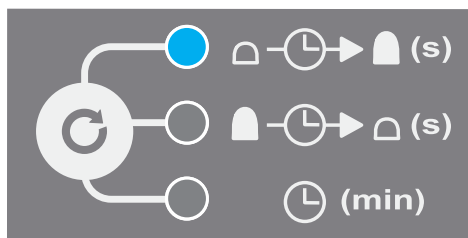

Inflate time in seconds

Deflate time in seconds

Treatment time in minutes

The indicator adjacent to the selected Therapy Setting lights, to show which parameter can be adjusted.

8.2.5 Therapy Setting Display and Therapy Setting Buttons

The Therapy Setting select button is used to select which parameter is shown on the Therapy Setting display: Inflate time, Deflate time or Treatment duration.

Note: *The default setting is Treatment duration.*

Inflate/Deflate times (in seconds)

To adjust the settings, press the Therapy Setting select button until the required indicator is illuminated.



Note: *These times can only be adjusted when the pump is in Standby.*

The Inflate time for each inflation mode can be set as follows:

Sequential: 30-95 seconds (15-80mmHg)
60-95 seconds (85-120mmHg)

Wave: 60-95 seconds.

LymphAssist: 60-95 seconds.

The Deflate time for each inflation mode can be set as follows:

Sequential: 10-95 seconds (15-80mmHg)
60-95 seconds (85-120mmHg)

Wave: 15-60 seconds (15-60mmHg)
60-95 seconds (65-80mmHg)
95 Seconds

LymphAssist: 15-60 seconds.

The Inflate and Deflate times can be increased and decreased in 5 second increments by pressing the + and – Therapy setting buttons.

Note: *If the + or – Therapy setting buttons are not pressed for 10 seconds, the pump reverts to the Treatment duration option.*

Treatment duration (in minutes)

- Make sure the Therapy Setting indicator adjacent to Treatment duration is illuminated. If not, press the Therapy Setting select button to select it.
- The Treatment duration can be adjusted in the range 10-99 minutes, in one minute increments, by pressing the + and – Therapy setting buttons.
- If you continue to hold down the + Therapy setting button when the Treatment duration gets to 99 minutes, CO will be shown on the Therapy Setting display to indicate continuous therapy.

Note: *The pump will automatically stop continuous therapy after two hours of continuous use.*

- When the therapy starts, the Treatment duration shown on the Therapy Setting display will count down, indicating the time remaining (to the nearest full minute) unless CO is selected.
- The Treatment duration can be adjusted at any time, in Run or Standby modes.
- At the end of the therapy, as set by the Treatment duration, the pump will stop.

8.2.6 Storing New Therapy Settings

The last selected patient therapy is stored and used as the default setting for the next therapy session.

For each of the three main Inflation Modes (Sequential, Wave and LymphAssist), the pump will store a separate set of four therapy settings (Pressure setting, Inflate time, Deflate time and Treatment duration).

If any of these four therapy settings are adjusted, the new setting is stored and used as the default setting whenever that inflation mode is next selected.

8.3 Pump Alarm

8.3.1 System Fault

1. If a system fault is detected, the pump will stop operating.
2. An audible warning will sound, and an F alarm message will appear on the Therapy Setting display.
3. Immediately disconnect the garment from the pump.
4. Press the Run/Standby button to re-run the self-test on the pump.
5. If the fault condition can not be rectified, call a service engineer.

9. Operation

These instructions cover the day-to-day operation of the Hydroven 12 system. Other operations, such as maintenance and repair, should only be carried out by suitably qualified personnel.

Note: Refer to “*Controls, Indicators and Alarms*” for a comprehensive description of the controls and indicators on the pump.

Note: If the operation or performance of the pump changes during use, refer to “*Routine Maintenance*” before calling a service engineer or contacting your local Huntleigh sales office.



WARNING: Bags supplied with this equipment may present a suffocation risk; to avoid the risk of suffocation, keep the bags away from babies and small children.



WARNING: Make sure the system is arranged so that the power cable does not pose a trip or strangulation hazard.

9.1 Preparing the System

1. Remove the system from the packaging. You should have the following items:
 - Hydroven 12 pump.
 - Hydroven 12 garment (arm or leg).
 - Hydroven 12 garment insert (optional).
2. Make sure the garment is the correct size for the limb, and that a garment insert is used if necessary (refer to “Garment Dimensions”).
3. Undo the zip on the garment.
4. If a garment insert is to be fitted to the garment, do the following:
 - Put the garment insert in between the two halves of the garment zip. Make sure the orientation of the garment and insert are correct: the two tubesets should be at the same end and on the outside of the garment and insert.
 - Fully fasten one of the zips between the garment and insert, leaving the other unfastened.
5. Before applying the garment (and insert, if fitted) to the limb, zip up the first 150 mm (6”) of the unfastened garment zip. Put the garment (and insert) onto the limb and fully fasten the zip.
6. Make sure the patient is in a comfortable position with the limb supported or elevated as necessary.

7. Connect the garment(s) to the two 12-way connectors on the pump, as follows:
 - If two garments are used (either two arm garments, two leg garments, or one arm/leg garment and one garment insert), one will be connected to the upper connector and the other connected to the lower connector. The two connections are interchangeable - both garments will inflate at the same time and to the same pressure.
 - If only one garment is used, it must be connected to the upper connector and the rubber cover must be folded over and securely fitted to the lower connector.

Note: *The connectors are push-fit and polarised to prevent incorrect orientation.*

8. If the patient is setting up or operating the system on his/her own, make sure that:
 - The pump is set up **before** garments are fitted.
 - The garments are connected to the pump before they are fitted onto the limbs.
9. Insert the mains power plug into a suitable mains power socket.
10. Switch on the mains power supply to the pump.
11. The pump will perform a short self-test and then go into Standby. Self-test may take between 15 to 20 seconds.
12. The Run and Sleep mode indicators are extinguished.
13. The indicators and displays on the pump control panel will show the previously selected therapy settings (refer to “Storing New Therapy Settings”).
14. Check the therapy settings and make any changes (refer to “Checking the Therapy Settings”).

9.2 Checking the Therapy Settings

To check the therapy settings, do the following:

1. Press the Inflation Mode select button until the required inflation mode is selected, as follows:
 - Sequential
 - Wave
 - LymphAssist
 - LymphAssist plus Sequential
 - LymphAssist plus Wave

Note: *The indicator adjacent to the selected Inflation Mode is illuminated. With linked therapy cycles, both Inflation Mode indicators are illuminated.*

2. Check the Pressure setting on the Pressure display.
3. Check the Inflate and Deflate times and Treatment duration on the Therapy Setting display. Press the Therapy Setting select button to select which parameter is shown on the Therapy Setting display, as follows:



Note: *The indicator adjacent to the selected Therapy Setting is illuminated.*

4. To change any of the four therapy settings, refer to “Changing the Therapy Settings”.
5. When the therapy settings are correct, the therapy session can then be started (refer to “Starting Therapy”).

9.3 Changing the Therapy Settings

To change the four therapy settings (Pressure setting, Inflate time, Deflate time and Treatment duration), do the following:

9.3.1 **Setting the Pressure**

1. The value shown on the Pressure display is the set pressure for the first garment chamber to be inflated.
2. The pressure can be adjusted in 5 mmHg increments by pressing the + and – Pressure setting buttons. If the + or – button is held down, the display change increases in speed.

Note: *For Sequential and Wave, the pump will not start inflating the next chamber in the garment until the set pressure is reached in the previous chamber. Therefore if the set pressure is greater than 80 mmHg, the Inflate and Deflate times may be longer than the selected values.*

9.3.2 **Setting the Inflate/Deflate Times**

For Sequential and Wave:

- The Inflate time is the total time to inflate all 12 chambers in the garment(s) during one cycle: from starting to inflate the first chamber to the last chamber being completely deflated.
- The Deflate time is the time between the end of one Sequential or Wave cycle and the start of the next cycle: from the last chamber being completely deflated in one cycle to starting to inflate the first chamber in the next cycle.

For LymphAssist:

- The Inflate time is the total time to inflate all 12 chambers in the garment during the single peristaltic Wave inflation at the start of the LymphAssist cycle.
- The Deflate time is the time between the end of one LymphAssist cycle and the start of the next cycle (refer to “LymphAssist Inflation”).

To set the Inflate or Deflate times, do the following:

1. Press the Therapy Setting select button until the desired Inflate or Deflate indicator is illuminated.
2. The Inflate and Deflate times can both be adjusted in 5 second increments, by pressing the + and – Therapy setting buttons. If the + or – button is held down, the display change increases in speed.

9.3.3 Setting the Treatment Duration

1. The Treatment duration is the default setting for the Therapy Setting display.
2. Make sure the Therapy Setting indicator adjacent to Treatment duration is illuminated. If not, press the Therapy Setting select button to select it.
3. The Treatment duration can be adjusted in one minute increments by pressing the + and – Therapy setting buttons.
If the + or – button is held down, the display change increases in speed.
4. If you continue to hold down the + Therapy setting button when the Treatment duration gets to 99 minutes, CO will be shown on the Therapy Setting display to indicate continuous therapy.

9.4 Starting Therapy

1. Make sure the pump is in Standby.

Note: *Make sure that all garment zips are completely and securely fastened before starting the therapy.*

2. Press and hold the Run/Standby button for 3 seconds to start the patient therapy.
3. The Run mode indicator will be illuminated and the Therapy Setting and Pressure displays will show the previously selected settings.
4. The pump will run through an initialisation process (this initialisation may take up to 15 seconds).
5. At the end of the initialisation process the pump compressor will start running and the garment(s) will start inflating.
6. When the therapy starts, the Treatment duration shown on the Therapy Setting display will count down, indicating the time remaining (to the nearest full minute) unless CO is selected.
7. The Treatment duration can be adjusted at any time during the treatment session (refer to “Setting the Treatment Duration”).



CAUTION: *Do not apply the garment to the limb unless it is partially zipped, as you may damage the garment zip.*



CAUTION: *Do not undo the zips or attempt to remove the garments during the therapy session or you may damage the zips. Make sure the therapy session has stopped and the garments have deflated before you remove the garments.*



CAUTION: *Do not stand or walk during the therapy session if leg garments are fitted.*

9.5 Stopping Therapy

1. There are two ways to stop the therapy, as follows:
 - The pump automatically stops at the end of the selected therapy time and the garments are deflated.
 - The pump can be stopped during the therapy by pressing and holding the Run/Standby button for 3 seconds. The pump will not stop immediately as it takes a few seconds to deflate the garment.
2. When the garments have been deflated, the Therapy Setting and Pressure displays both change to zero and the pump gives 5 beeps to confirm that the treatment session has been completed.
3. The Run indicator is extinguished.
4. Press the Run/Standby button to reset the pump to Standby.

9.6 Storing New Therapy Settings

1. If the Inflation Mode, Pressure setting, Inflate time, Deflate time or Treatment duration are adjusted, the new setting is stored and used as the default setting for the next therapy session.
2. The new setting is stored in the pump five seconds after the last function button has been pressed.
3. If the pump is switched off during this five second period after the last function button has been pressed, the new setting will NOT be saved.

9.7 Control Panel Lockout

The buttons on the pump control panel can be “locked” to prevent the patient from changing the therapy settings on the control panel.

9.7.1 **Pressure Setting**

1. To lock the Pressure setting, and prevent accidental alterations during the therapy session, press the following two buttons simultaneously:
 - The + Pressure setting button.
 - The – Pressure setting button.
2. To unlock the Pressure setting, press the following three buttons simultaneously:
 - The + Pressure setting button.
 - The – Pressure setting button.
 - The Therapy Setting select button.

9.7.2 Inflation Mode and Therapy Time Settings

1. To lock the Inflation Mode, Inflate time, Deflate time and Treatment duration settings, and prevent accidental alterations during the therapy session, press the following two buttons simultaneously:
 - The + Therapy setting button.
 - The – Therapy setting button.

Note: *In the Lockout mode, the Treatment duration is set to the nearest 5 minutes (rounded down).*

2. To unlock the Inflation Mode, Inflate time, Deflate time and Treatment duration settings, press the following three buttons simultaneously:
 - The + Therapy setting button.
 - The – Therapy setting button.
 - The Therapy Setting select button.

10. Decontamination

The following processes are recommended, but should be adapted to comply with the local or national guidelines (Decontamination of Medical Devices) which may apply within the Healthcare Facility or the country of use. If you are uncertain, you should seek advice from your local Infection Control Specialist.

The Hydroven 12 system should be routinely decontaminated between patients and at regular intervals while in use; as is good practice for all reusable medical devices.



WARNING: Remove the electrical supply to the pump by disconnecting the mains power cord from the mains power supply before cleaning.

Protective clothing should always be worn when carrying out decontamination procedures.



CAUTION: Do not use Phenol-based solutions or abrasive compounds or pads during the decontamination process as these will damage the surface coating. Avoid immersing electrical parts in water during the cleaning process. Do not spray cleaning solutions directly onto the pump. Do not immerse the tubeset in water.

10.1 Cleaning

Clean all exposed surfaces and remove any organic debris by wiping with a cloth moistened with a simple (neutral) detergent and water.

Do not allow water or cleaning solutions to collect on the surface of the pump.

10.2 Chemical Disinfection

We recommend a chlorine-releasing agent, such as sodium hypochlorite, at a strength of 1,000ppm available chlorine (this may vary from 250ppm to 10,000ppm depending on local policy and contamination status).

Wipe all cleaned surfaces with the solution, then wipe using a cloth moistened with water and dry thoroughly.

Alcohol based disinfectants (strength 70%) may be used as an alternative.

Ensure the product is dry before storage.

If an alternative disinfectant is selected from the wide variety available we recommend that suitability for use is confirmed with the chemical supplier prior to use.

10.3 Cleaning and Sterilising Garments

Wipe down garments using a neutral detergent or soap powder at 40°C. Dry thoroughly.

After cleaning gas sterilisation is possible, however:

- Do not exceed 51°C (120°F).
- Do not autoclave.

11. Routine Maintenance

11.1 Hydroven 12 System

11.1.1 Maintenance

This equipment has been designed to be virtually maintenance free between service periods.

11.1.2 Servicing

Huntleigh will make available on request service manuals, component parts lists and other information necessary for Huntleigh trained personnel to repair the system.

11.1.3 Service Period

Huntleigh recommend that the Hydroven 12 pump is serviced every 24 months by a Huntleigh approved service agent.

11.2 General Care, Maintenance and Inspection

11.2.1 Pump

Check all electrical connections and the mains power cord for signs of excessive wear.

In the event of the pump being subjected to abnormal treatment, e.g. immersed in water or dropped, the unit must be returned to an authorised service centre.

11.2.2 Garments

Inspect the garment for signs of wear or any tears, and check that all zips and fasteners are secure.

Check the security of all internal pneumatic connections.

11.3 Serial Number Labels

11.3.1 Pump

The serial number label is secured to the rear case of the pump. Quote this serial number when requesting service.

11.3.2 Garments

The serial number label is attached to the garment.

12. Trouble Shooting

If you should encounter a problem, please follow the fault finding guide below. If the fault cannot be rectified, please refer to Service.

Fault	Check	Remedy
Pump does not operate.	Is power switch on?	Check switch.
	Is power cord plugged in correctly?	Check connections.
	Fuse blown?	Call service engineer.
Pump operates but garment will not inflate.	Blockage in garment supply tube.	Ensure that the tube airway is clear.
	Garment not fitted correctly to pump.	Check connections.
	Air leak in garment.	Check garment. Replace if defective.
Therapy Setting display shows "F"	-	Internal fault. Return the pump for service.

Note: *If the trouble shooting procedures do not return the system to normal performance, stop using the system immediately and call the service engineer or return the unit to Huntleigh for service. Refer to "Warranty & Service".*

13. Accessories

Garments and Garment Inserts				
Arm Garment Dimensions				
Garment Part No.	316A68		316A78	
Length (shoulder to fingertips)	68 cm (26.8")		78 cm (30.7")	
Circumference (at shoulder)				
Arm Garment	62 cm (24.4")		62 cm (24.4")	
with Garment Insert	79 cm (31.1")		79 cm (31.1")	
Corresponding Insert piece part No.	316AI68		316AI78	
Width of Insert (at shoulder)	17 cm (6.7")		17 cm (6.7")	
Leg Garment Dimensions	Standard		Large	
Garment Part No.	316L76S	316L84S	316L76W	316L84W
Length (top-of-thigh to heel)	76 cm (29.9")	84 cm (33.1")	76 cm (29.9")	84 cm (33.1")
Circumference (at top-of-thigh)				
Leg garment	71 cm (28.0")	71 cm (28.0")	79 cm (31.1")	79 cm (31.1")
with garment insert	90 cm (35.4")	90 cm (35.4")	98 cm (38.6")	98 cm (38.6")
Corresponding insert piece Part No.	316LI76	316LI84	316LI76	316LI84
Width of insert (at top-of-thigh)	19 cm (7.5")	19 cm (7.5")	19 cm (7.5")	19 cm (7.5")
Materials				
Inner Material	PU-coated, knitted Nylon			
Outer material:	Double PU-coated, woven Nylon			



WARNING: Use only recommended accessories listed in this manual.

14. Specifications

14.1 Equipment Classification

Type of protection against electric shock.	Class II, Double Insulated
Degree of protection against electric shock 	Type BF
Mode of operation.	Continuous
Degree of protection against solid and liquid ingress	IP21* - Protection against ingress of solid objects more than 12.5mm diameter and water droplets falling vertically. IPX0* - No Protection
Degree of safety of application in the presence of a flammable anaesthetic	Equipment not suitable for use in the presence of a FLAMMABLE ANAESTHETIC MIXTURE WITH AIR, OXYGEN OR NITROUS OXIDE

* See product label for IP Rating

14.2 General

Model	Hydroven 12 System
Part Numbers	316001 UK 316003 Canada 316009AU Australia & New Zealand
Pressure Range	Sequential: 15 - 120 mmHg Wave: 15 - 100 mmHg LymphAssist: 15 - 40 mmHg all \pm 5%
Supply Voltage	100 - 230 V AC
Supply Frequency	50 - 60 Hz
Fuse Type	5A to BS1362 (UK only)
Power Input	38 - 77 VA
Case Material	Fire Retardent ABS Plastic
Size	250 x 130 x 290 mm
Weight	3.8 kg

14.3 Environmental

Condition	Temperature range	Relative Humidity	Atmospheric Pressure
Operating	5°C to 40°C (41°F to 104°F)	30% to 75% (non condensing)	700 to 1060 hPa
Storage and transport (Long term)	10°C to 40°C (50°F to 104°F)	20% to 95% (non condensing)	700 to 1060 hPa
Storage and transport (short term)	-25°C to 70°C (-13°F to 158°F)	20% to 95%	500 to 1060 hPa















Note: *When exposed to extreme temperature during storage, the pump must be allowed to adjust to normal temperatures for a minimum of 12 hours before use. Failure to do so may result in accelerated wear of mechanical components.*







14.4 Standards Compliance

EN60601-1:1990/A13:1996 and IEC 60601-1:1988/A2:1995	Medical Electrical Equipment Part 1 General Requirements for Safety
UL60601-1, UL2601-1 and CAN/CSA C22.2 No. 601.1-M90	
EN60601-1:2006 and IEC 60601-1:2005	
AAMI/ANSI ES60601-1:2006 and CAN/CSA C22.2 No.60601.1(2008)	
EN60601-1-11: 2010*	
EN60601-1-2: 2001	General requirements for safety: Electromagnetic compatibility
BS EN 980: 2008	Symbols for use in the labelling of medical devices

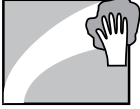
* Only applies to IP21 rated products (see product label for IP rating)

15. Product Labelling

Symbols			
	Hydroven 12 is Class II, double insulated according to the definitions in BS EN 60601-1:1990		
	Applied parts are type BF according to the definitions in BS EN 60601-1:1990		
	Refer to this document (Instructions for Use) for a description of the product classification (3rd Edition).		
	Standby. Note: Unit is not isolated from mains supply.		
	With respect to electric shock, fire and mechanical hazards only in accordance with CAN/CSA-C22.2 No. 60601.1 (2008). MEDICAL EQUIPMENT		
	This symbol signifies that this product, including its accessories and consumables is subject to the WEEE (Waste Electrical and Electronic Equipment) regulations and should be disposed of responsibly in accordance with local procedures.		
	Refer to this document (Instructions for Use) for a description of the product classification (2nd Edition).		
	This symbol signifies that this product complies with the essential requirements of the Medical Devices Directive 93/42/EEC as amended by 2007/47/EC		
	Follow Instructions for Use		Alternating Current (AC)
	Serial Number		Reference Number
	Manufacturer		Cardboard packaging can be recycled.

Cleaning Symbols			
	Wipe surface with damp cloth		Use solution diluted to 1000 ppm of Available Chlorine
	Do not iron		Do Not Use Phenol-based cleaning Solutions
	Do not dry clean		Do not tumble dry

16. End of Life Disposal

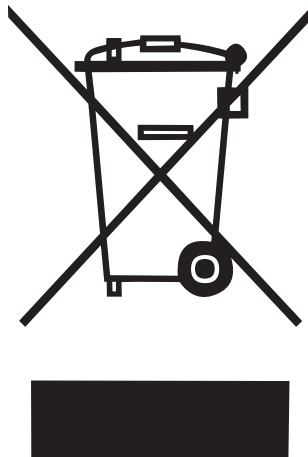

This symbol signifies that this product, including its accessories and consumables is subject to the WEEE (Waste Electrical and Electronic Equipment) regulations and should be disposed of responsibly in accordance with local procedures.

17. Warranty & Service

Huntleigh Healthcare Diagnostic Products Division standard terms and conditions apply to all sales. A copy is available on request. These contain full details of warranty terms and do not limit the statutory rights of the consumer.

17.1 Service Returns

United Kingdom only

If for any reason the Hydroven 12 has to be returned, please:

- Clean the product following the instructions in this manual.
- Pack it in suitable packing.
- Attach a decontamination certificate (or other statement declaring that the product has been cleaned) to the outside of the package.
- Mark the package 'Service Department '

For further details, refer to NHS document HSG(93)26.

Huntleigh Healthcare Ltd reserve the right to return product that does not contain a decontamination certificate.

Service Department.
Huntleigh Healthcare, Diagnostic Products Division,
35, Portmanmoor Rd.,
Cardiff. CF24 5HN
United Kingdom.

Tel: +44 (0)29 20485885
Fax: +44 (0)29 20492520
Email: sales@huntleigh-diagnostics.co.uk
service@huntleigh-diagnostics.co.uk
www.huntleigh-diagnostics.com

International Customers

Contact your local office listed on the inside back cover.

INTERNATIONAL

ArjoHuntleigh International Ltd
ArjoHuntleigh House
Houghton Hall Park
Houghton Regis
UK-DUNSTABLE LU5 5XF
Tel: +44 (0) 1582 745 800
Fax: +44 (0) 1582 745 866
E-mail: international@arjohuntleigh.com

DEUTSCHLAND

HNE Healthcare GmbH
Industriering Ost 66
DE-47906 Kempen
Tel: +49 (0) 2152 551110
Fax: +49 (0) 2152 551120
E-mail: verkauf@huntleigh.de

SVERIGE

ARJO Scandinavia AB
Hans Michelsensgatan 10
SE-211 20 MALMÖ
Tel: +46 (0) 10 494 7760
Fax: +46 (0) 10 494 7761
E-mail: kundservice@arjohuntleigh.com

NORGE

ArjoHuntleigh Norway AS
Olaf Helsets vei 5
N-0694 OSLO
Tel: +47 22 08 00 50
Faks: +47 22 08 00 51
E-mail: no.kundeservice@arjohuntleigh.com

DANMARK

ArjoHuntleigh A/S
Vassingerødvej 52
DK-3540 LYNGE
Tel: +45 49 13 84 86
Fax: +45 49 13 84 87
E-mail: dk_kundeservice@arjohuntleigh.com

USA

ArjoHuntleigh Inc.
2349 W Lake Street Suite 250
US-Addison, IL 60101
Tel: +1 630 307 2756
Free: +1 800 323 1245 Institutional
Free: +1 800 868 0441 Home Care
Fax: +1 630 307 6195
E-mail: us.info@arjohuntleigh.com

CANADA

ArjoHuntleigh
90 Matheson Boulevard West
Suite 300
CA-MISSISSAUGA, ON, L5R 3R3
Tel/Tél: +1 905 238 7880
Free: +1 800 665 4831 Institutional
Free: +1 800 868 0441 Home Care
Fax: +1 905 238 7881
E-mail: info.canada@arjohuntleigh.com

AUSTRALIA

ArjoHuntleigh Pty Ltd
78, Forsyth Street
O'Connor
AU-6163 Western Australia
Tel: +61 89337 4111
Free: +1 800 072 040
Fax: + 61 89337 9077

NEW ZEALAND

ArjoHuntleigh Ltd
41 Vestey Drive
Mount Wellington
NZ-AUCKLAND 1060
Tel: +64 (0) 9 573 534
Free Call: 0800 000 151
Fax: +64 (0) 9 573 5384
E-mail: nz.info@ArjoHuntleigh.com

HUNTLEIGH *...performance for life*

Huntleigh Healthcare Ltd. - Diagnostic Products Division

35 Portmanmoor Road, Cardiff, CF24 5HN, United Kingdom

T: +44 (0)29 20485885 **F:** +44 (0)29 20492520 **E:** sales@huntleigh-diagnostics.co.uk

W: www.huntleigh-diagnostics.com



Registered No: 942245 England & Wales. Registered Office:

ArjoHuntleigh House, Houghton Hall Business Park, Houghton Regis, Bedfordshire, LU5 5XF

©Huntleigh Healthcare Limited 2014

AN **ARJOHUNTLEIGH** COMPANY, MEMBER OF GETINGE GROUP

® and ™ are trademarks of Huntleigh Technology Limited

As our policy is one of continuous improvement, we reserve the right to modify designs without prior notice.

779354-EN-3